

MEGA[™]
CONSTRUX

MASTERS OF THE UNIVERSE

GCP90

WIND RAIDER ATTACK
ATTAQUE DU WIND RAIDER
ATAQUE DE WIND RAIDER



MEGA CONSTRUX™ BEYONDERS™*

DOWNLOAD THE APP | TÉLÉCHARGE L'APPLICATION | DESCÁRGATE LA APLICACIÓN | DESCARREGA A APLICAÇÃO | SCARICA L'APP | APP ZUM HERUNTERLADEN | POBIERZ APLIKACJĘ | DOWNLOAD DE APP
СКАЧАЙ ПРИЛОЖЕНИЕ | ΚΑΤΕΒΑΣΤΕ ΤΗΝ ΕΦΑΡΜΟΓΗ | UYGULAMAYI İNDİR | حمل التطبيق

*Tablet only | Tablette uniquement | Solo tableta | Apenas tablet | Solo Tablet | Nur Tablet | Tylko na tablet | Alleen tablet
Только для планшета | Móvo tablet | Yalnızca tablet | جهاز لوحي فقط



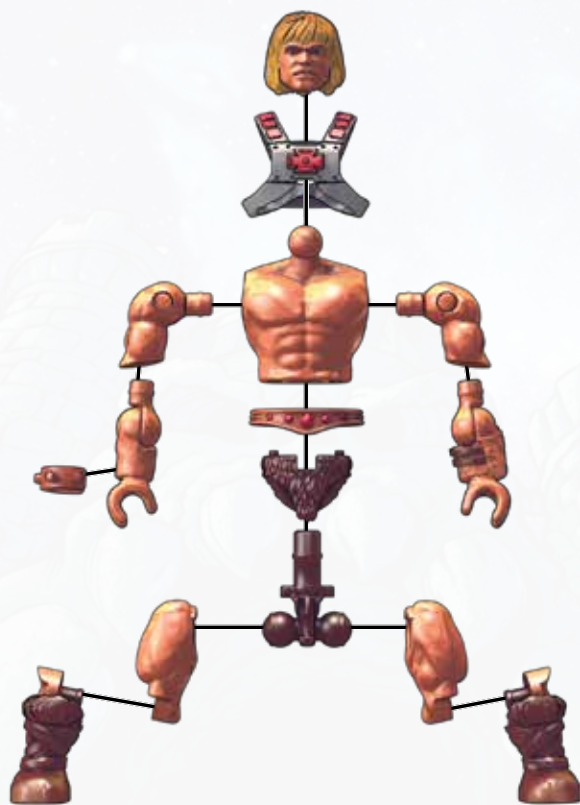

1



1X

1X

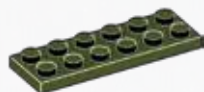

1X



2



2X



4X



1X



1X



1X



1X

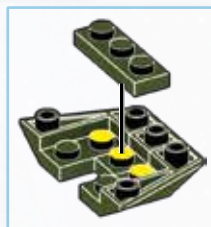
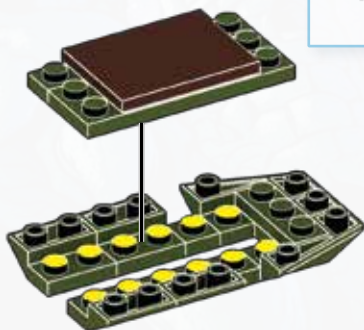

3



1X



1X



1X



1X

4



1X

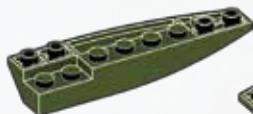

1X



1X

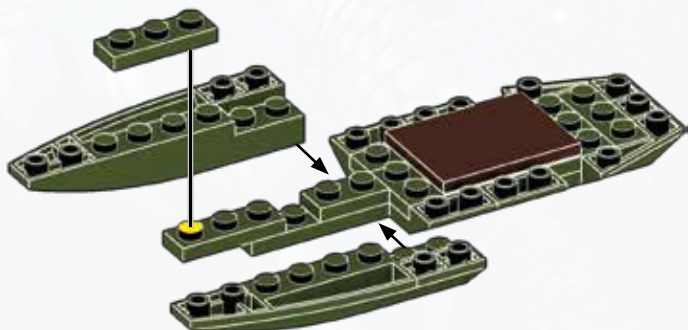
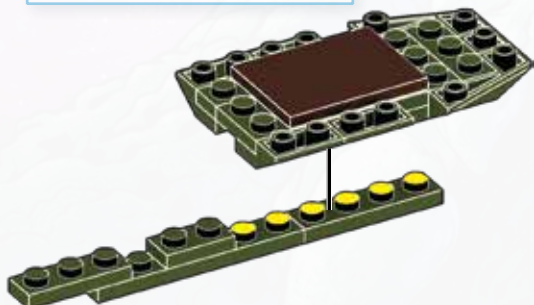
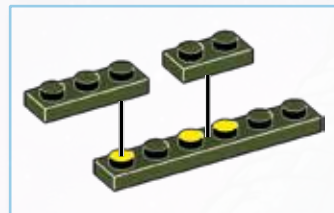

5



1X

2X

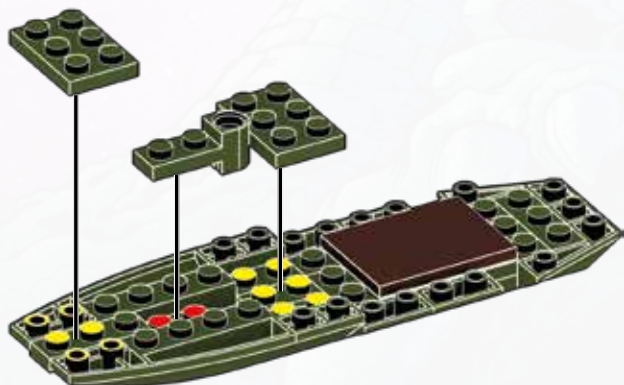

6



3X

1X

1X

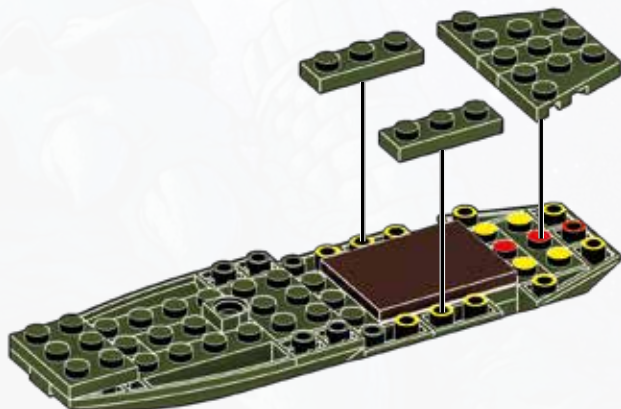
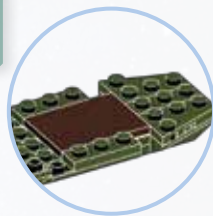

7



2X



Place temporary pieces | Placer les pièces temporaires | Colocar las piezas provisionales | Colocar as peças temporárias
 Posizionare i pezzi provvisori | Die vorübergehend benötigten Teile platzieren | Umieść tymczasowe elementy
 Plaats tijdelijke delen | Поместите временные детали | Placér midlertidige stykker. | Placera temporära delar
 Plasser midlertidige deler | Aseta väliaikaiset osat | Τοποθετήστε το προσωρινό κομμάτι | Geçici parçaları yerleştirin
 放置临时件 | 暫定ピースを配置してください | ضع القطع المؤقت

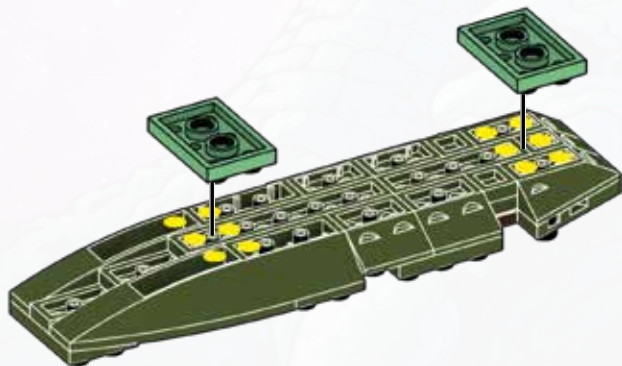

1



2

8



2X

1X



1X

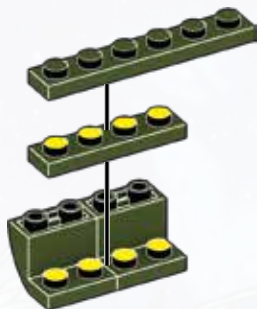

9



1X

2X



1X

1X

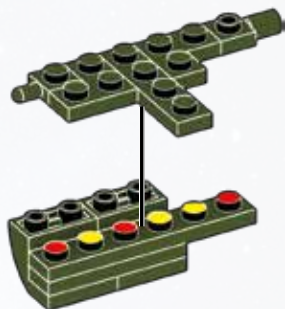

10



1X



2X



1X



1



2

11

2X

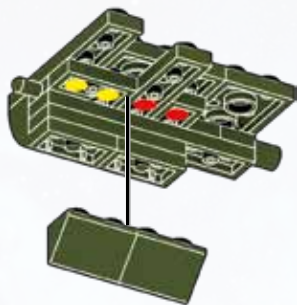

1

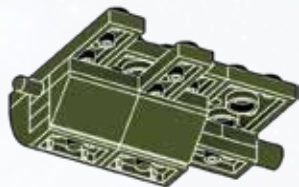

2

12

2X



1X

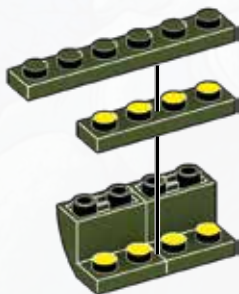

1X

**13**

1X



2X



1X



1X

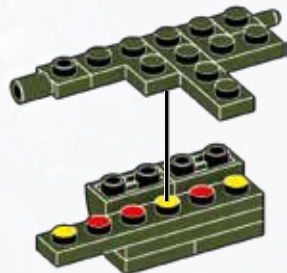

14



1X



2X



1X

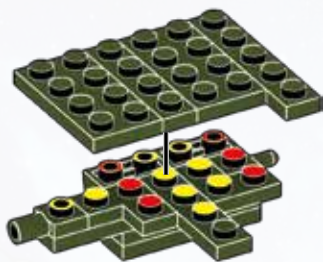

1

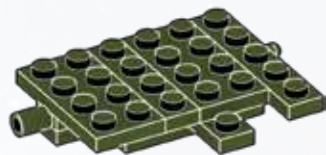

2

15



2X

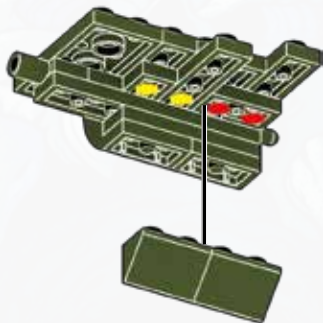

1

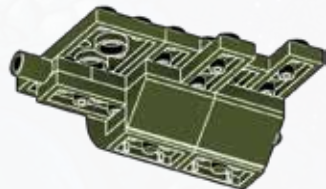

2

16

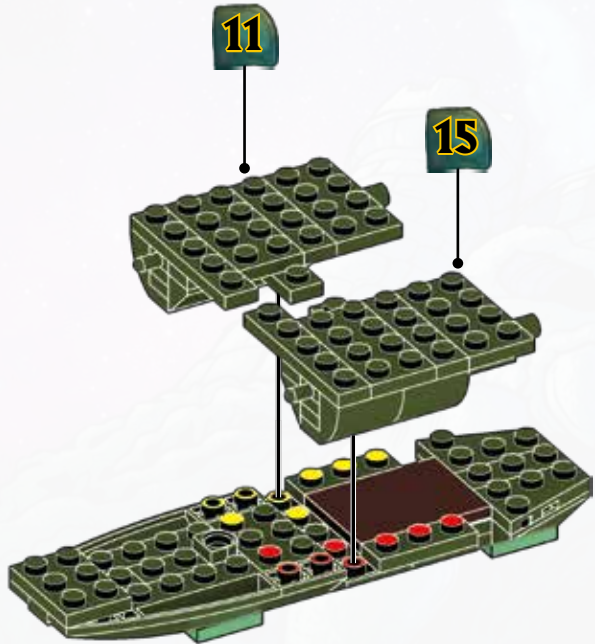

17

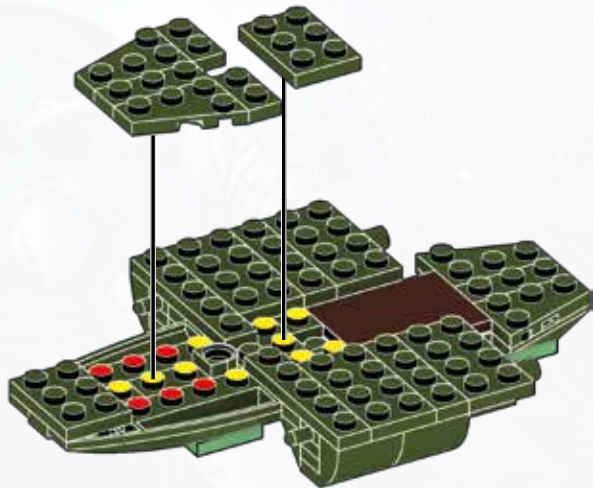
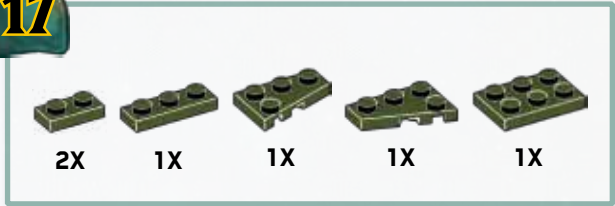

18



1X

2X

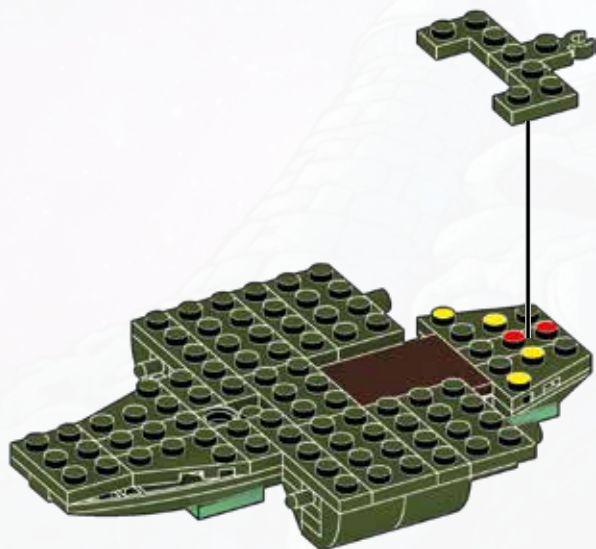

19



1X

2X

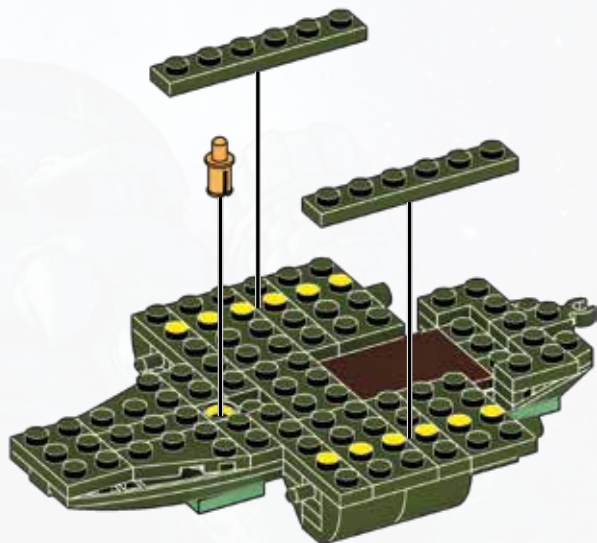

20



6X



4X



1X



1X

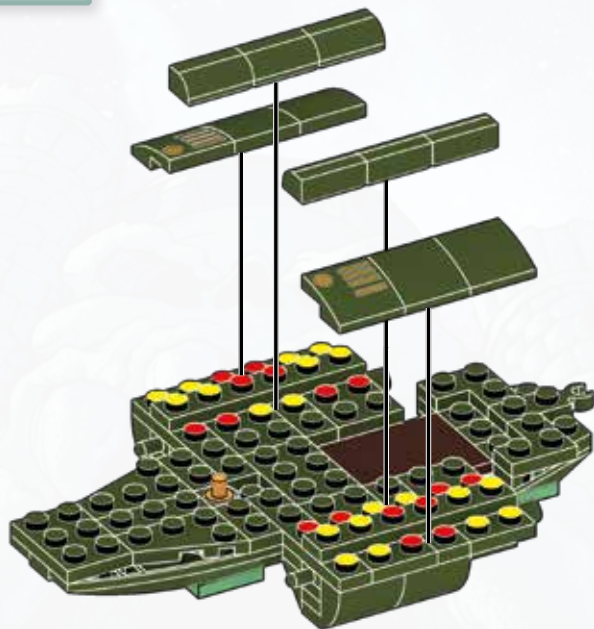

21



2X



2X



2X



1



2

X2

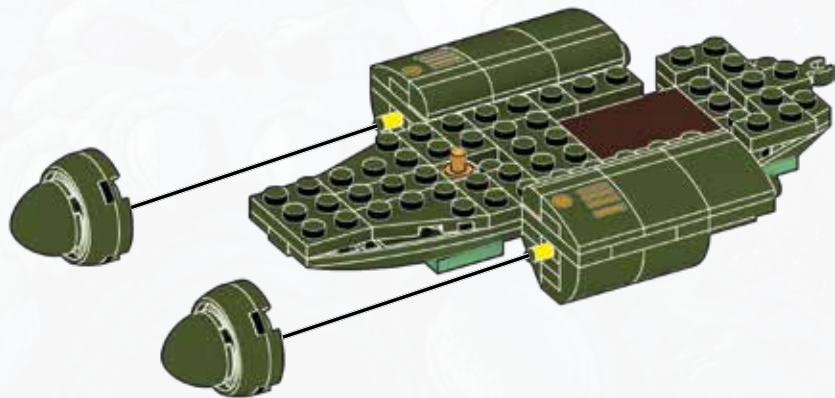

22



1X

1X

1X

4X

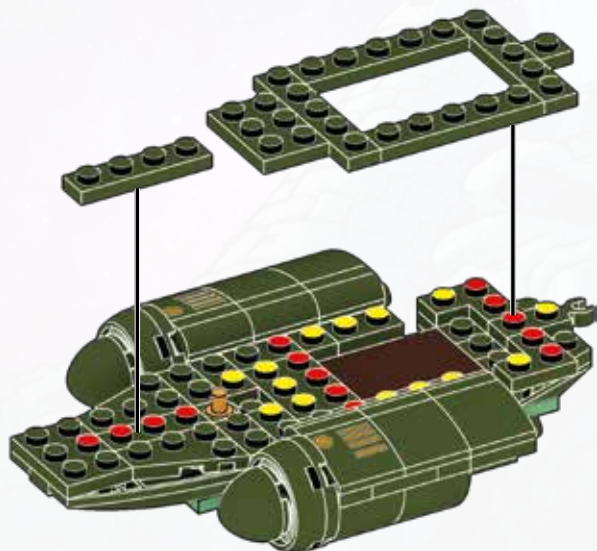

23



2X

2X

1X

1X

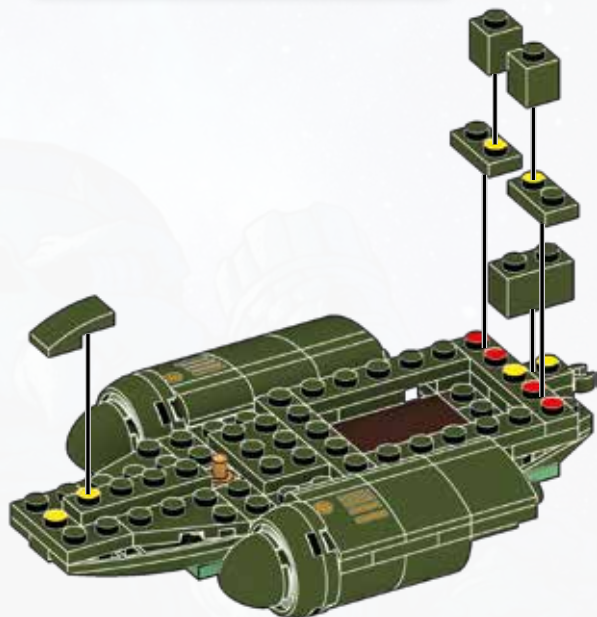

24



1X

1X

1X

25



1X

1X

1X

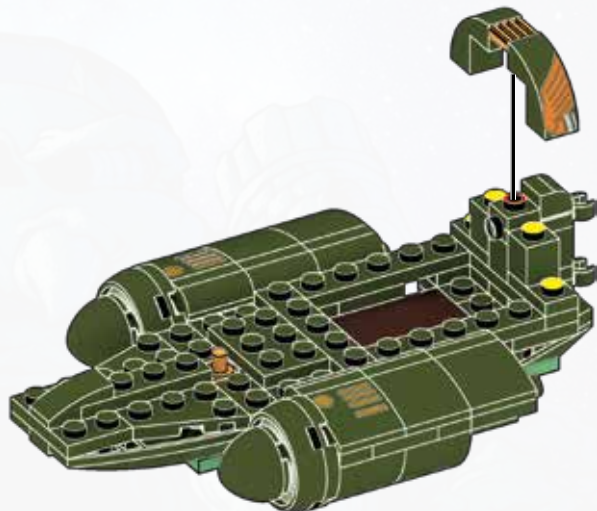
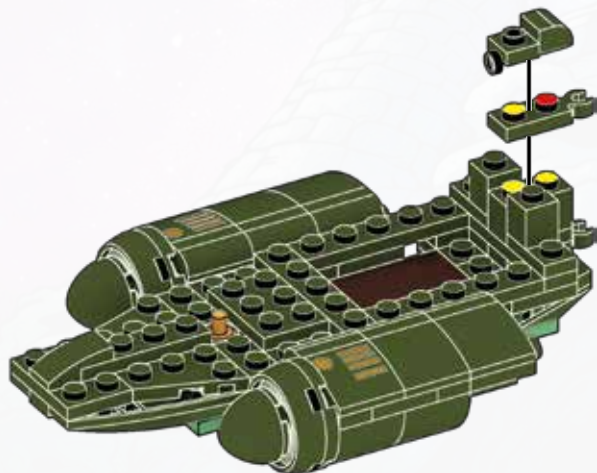

26



3X



1X

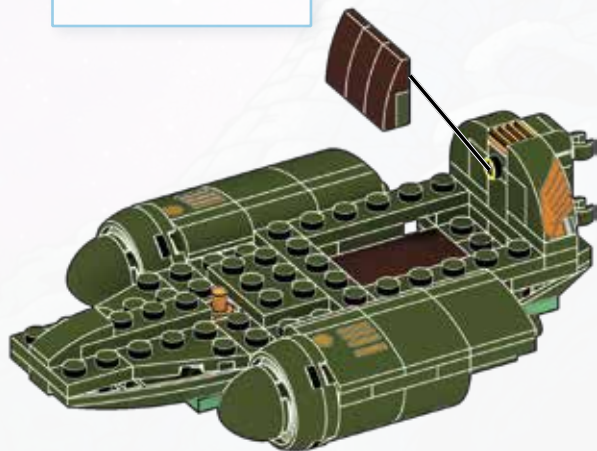
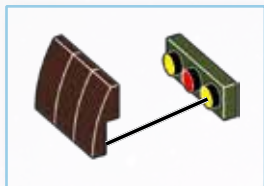

27



2X



1X



1X

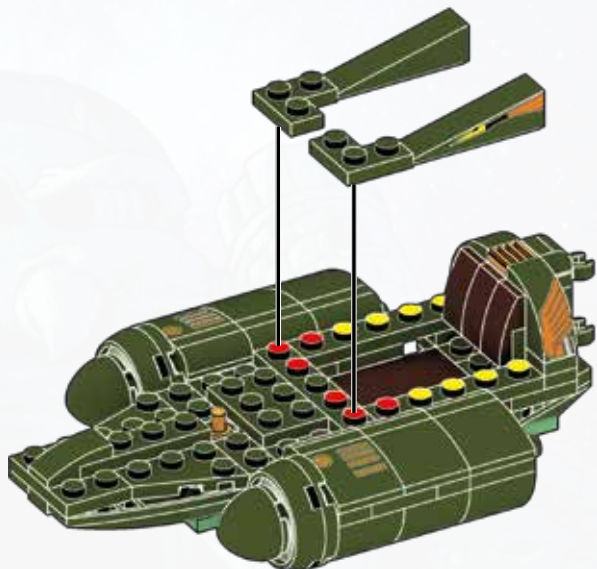

28



1X



1X



2X



1X



2X



2X



2X



1X



1X



1X



1X



1

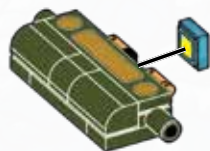

2

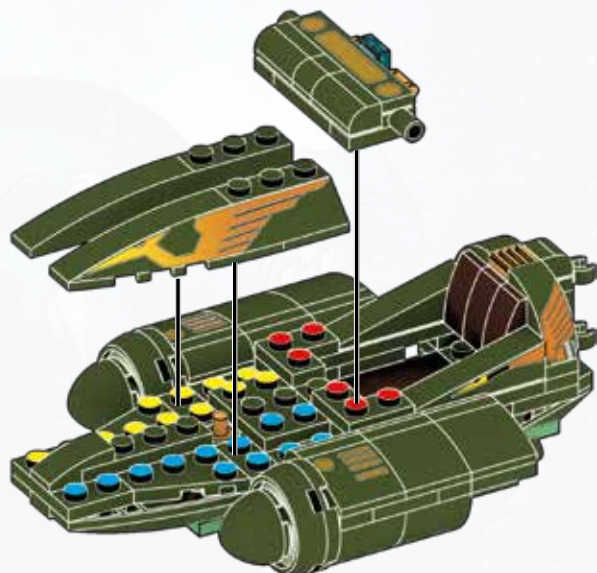

29



1X



1X



1X

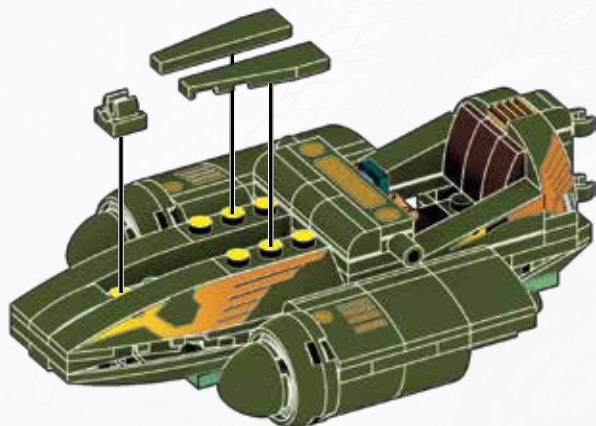

1

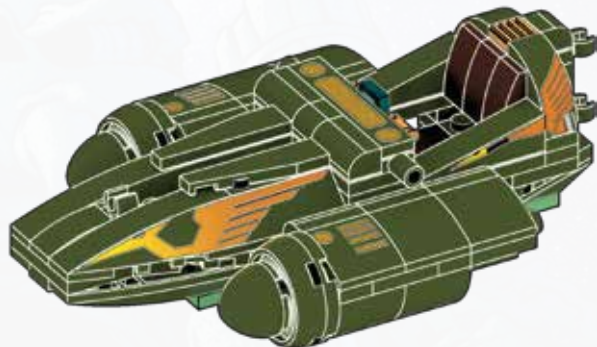

2

30



2X



2X



2X

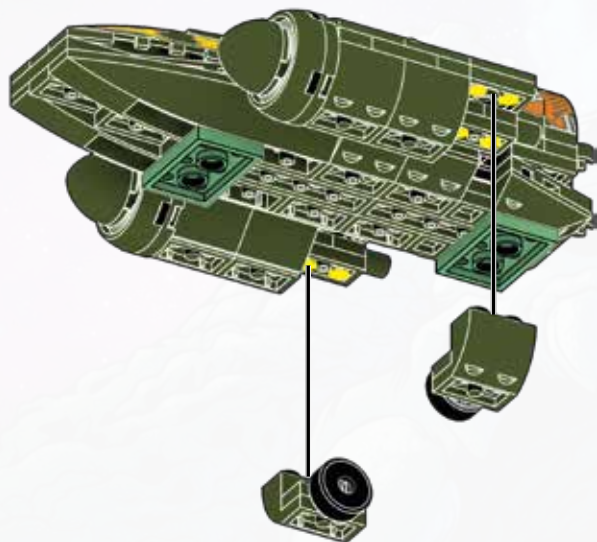

1



1

2

3

X2

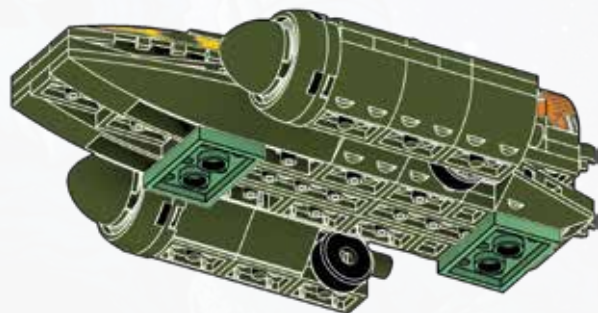

2

31



2X



2X



2X



X2

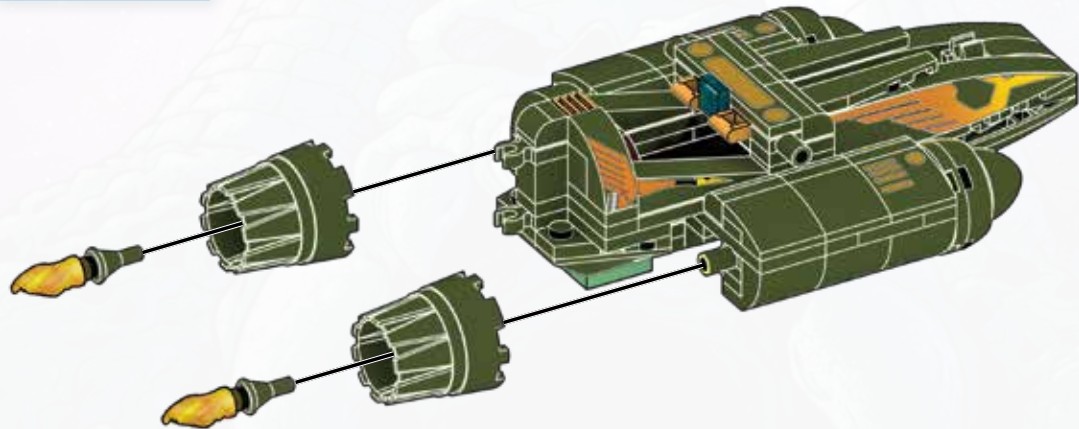
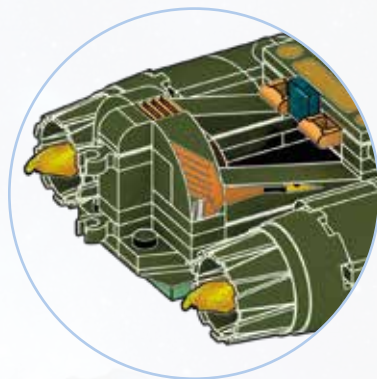

32



1X



1X

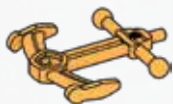

1X



1X

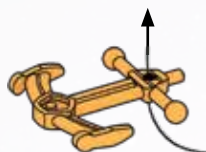

1



2



3

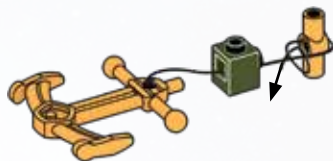

4

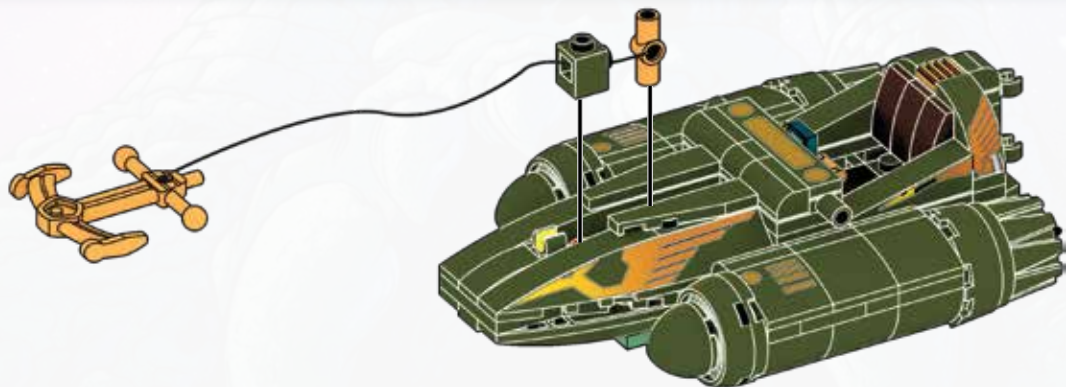

33



1X

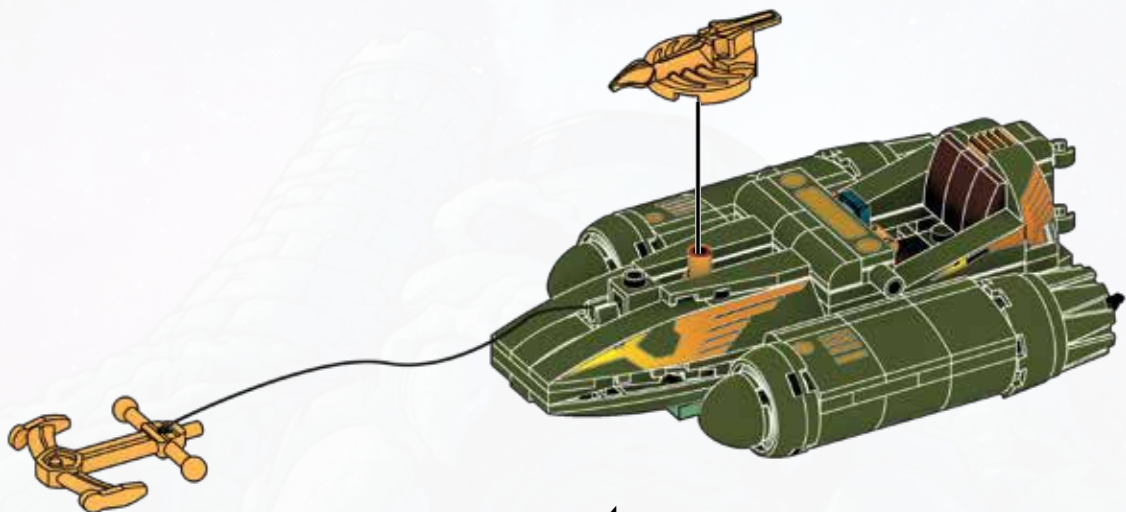

1

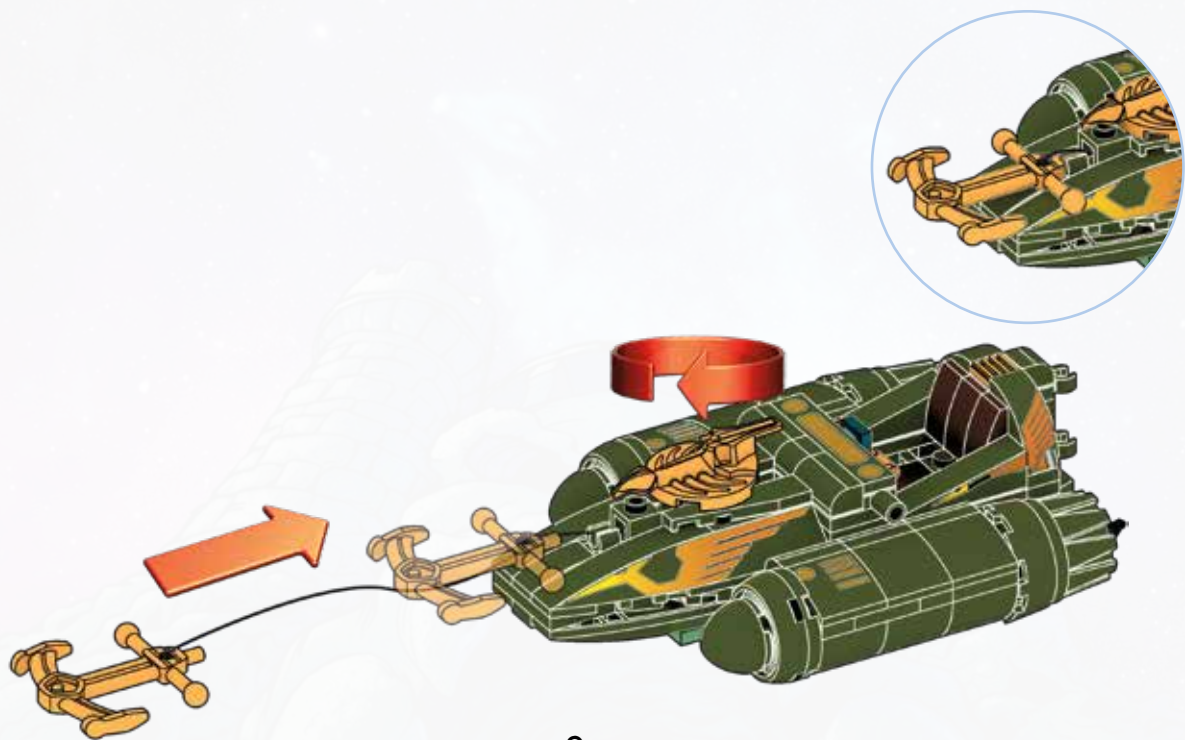

2

34



2X



2X



1X



1X



1X

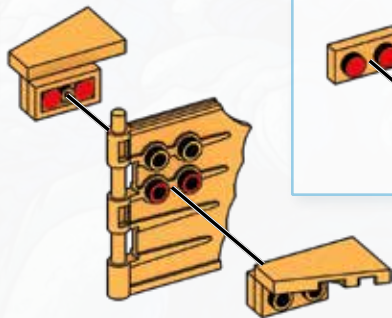
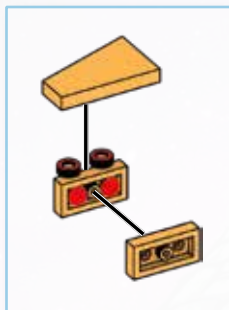

1

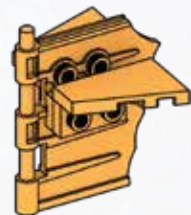
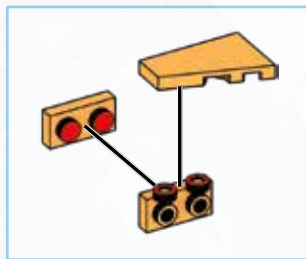

2

35



2X



2X



2X

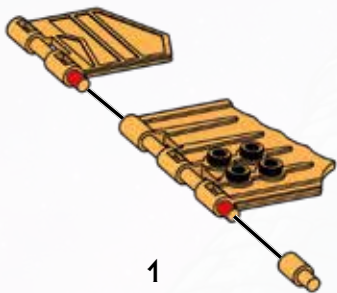

36



Remove temporary pieces | Retirez les pièces temporaires | Retirar las piezas provisionales. | Remover as peças temporárias | Rimuovere i pezzi provvisori | Die vorübergehend benötigten Teile entfernen | Usunač elementy tymczasowe | Verwijder tijdelijke delen | Удалите временные детали | Fjern midlertidige stykker. | Ta bort temporära delar | Fjern midlertidige deler | Poista väliaikaiset osat | Αφαιρέστε τα προσωρινά κομμάτια | Geçici parçaları çıkarın
移除临时件 | 暂定ピースを外してください | انزع القطع المؤقتة

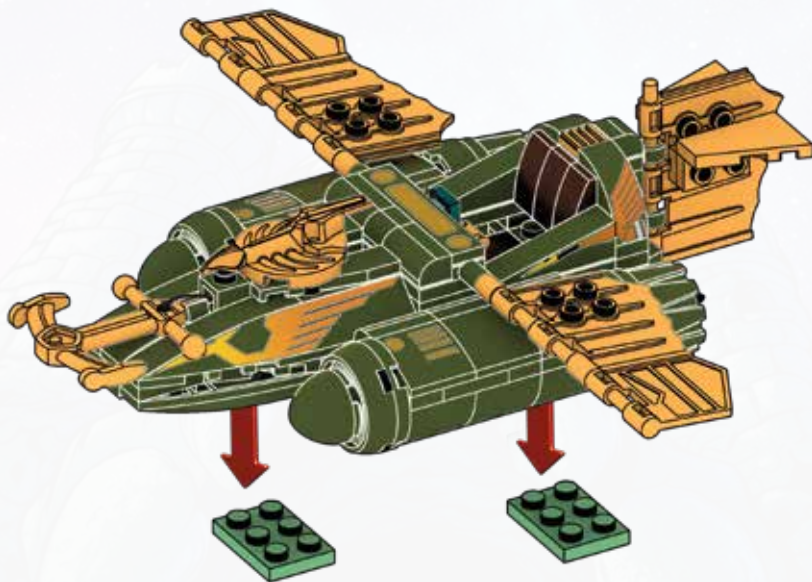

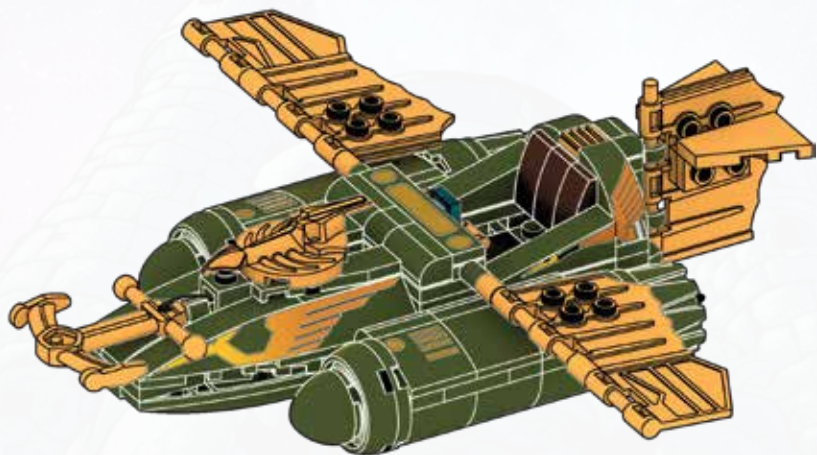



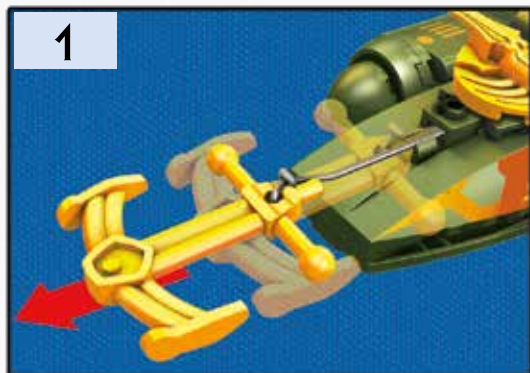

2x
MA74397FM

2x
AM73012XN

1x
M07223AAV

1x
AM79666FM

3x
MA03328XN

1x
AM79590XN

1x
MA77574XN

2x
MA17787XN

1x
MA19999XN

2x
MA1086XN

1x
MA07629XN

1x
AM72244FM

2x
MA1140XN

4x
MA76058XN

2x
AM79070FM

2x
MA76054FM

1x
AM76867FM

2x
MA11971F

7x
MA09393XN

2x
MA09393FM

2x
MA18221XN

1x
MA72002XN

4x
MA16679XN

8x
MA03017XN

1x
AM78486XN

3x
AM78486KN

1x
MA09013XN

1x
AS-GCP90-06

1x
AS-GCP90-05

2x
AM79687XN

2x
AM16914AMZ

4x
MA74106XN

1x
AS-GCP90-09

1x
AS-GCP90-08

2x
AM72238XN

2x
AM72240XN

6x
MA08482XN

1x
AM78107XN

8x
MA15484XN

4x
MA18223XN

2x
MA72917XN

1x
AM18224XN

1x
AM18225XN

2x
MA17073XN

2x
MA17074XN

5x
MA03772XN

2x
MA03772AXT

8x
MA1314XN

1x
AS-GCP90-04

1x
AS-GCP90-03

8x
MA09593XN

4x
MA09493XN

1x
AM76451XN

1x
AM76452XN

1x
AM72025XN

6x
MA07475XN

1x
AS-GCP90-07

6x
MA09292XN



1x
MA19899FM



1x
MA19898FM



2x
AM15493XN



1x
AM79983FM



1x
AM79984FM



2x
AM79985FM



3x
AM79986FM



1x
AS-GCP90-01



1x
AS-GCP90-02



1x
AM09187XN



1x
AM09186XN



2x
MA76357AXT



1x
MA1480XN



1x
AX-GCP90-01



1x
AM79763APG



1x
AM79172AEN



1x
FIG-GCP90-A



1x
FIG-GCP90-B

Please read these instructions carefully before first use and keep them for future reference.
Il est recommandé de lire attentivement ce feuillet avant la première utilisation et de le conserver pour référence future.

Leer estas instrucciones cuidadosamente antes de la primera utilización y guardarlas para referencia futura.

Leia as instruções antes do primeiro uso e guarde-as para futura referência.

Leggere le istruzioni prima di cominciare ad usare il gioco e conservarle per reference future.

Die Gebrauchsanleitung bitte durchlesen und aufbewahren.

Proszę uważnie przeczytać instrukcję obsługi przed pierwszym użyciem, a następnie zachować ją na przyszłość.

Wij raden u aan deze handleiding zorgvuldig te lezen en te bewaren voor eventuele raadpleging op een later tijdstip.

Внимательно прочитайте инструкцию перед первым использованием и сохраните ее для дальнейшего использования.

Vær venlig at læse disse instruktioner omhyggeligt inden ibrugtagning og opbevar dem til fremtidigt brug.

Läs noggrant igenom dessa instruktioner innan du använder produkten för första gången och spara dem för ev. framtida frågor.

Disse instruksjonene nøye før første gangs bruk, og ta vare på dem for fremtidige oppslag.

Lue nämä ohjeet huolellisesti ennen ensimmäistä käyttöä ja säilytä ne myöhempäa tarvetta varten.

Διαβάστε προσεκτικά τις οδηγίες πριν από τη χρήση και κρατήστε τις για μελλοντική αναφορά.

Ilk kullannidan önce talimatları dikkatlice okumanızı ve bu bilgileri ileride tekrar bakabilmek için saklamanızı öneririz.

第一次使用前，請仔細閱讀本說明書并保留以備將來參考。

初めてご使用になる前に、この説明書をよくお読みください。また、本書は将来いつでも参照できるように保管してください。

رجاء قراءة هذه التعليمات بعناية قبل الاستخدام والاحتفاظ بها للعودة إليها مستقبلاً.

يجب قراءة هذه التعليمات بعناية قبل الاستخدام والاحتفاظ بها للعودة إليها مستقبلاً.



(P) D714,887 , D781,964, D797,203

HE-MAN™, MASTERS OF THE UNIVERSE™

and associated trademarks and trade dress are owned by, and used under license from Mattel, Inc. ©2018 Mattel. All Rights Reserved.

**MEGA
CONSTRUX™**

MASTERS OF THE UNIVERSE

EXPAND YOUR COLLECTION!
AGRANDISSEZ VOTRE COLLECTION!
¡AMPLÍA TU COLECCIÓN!
AUMENTE A SUA COLEÇÃO!



GDV86



Each sold separately and subject to availability. / Produits vendus séparément, selon la disponibilité. / Se venden por separado y están sujetos a disponibilidad. / Vendidos em separado e sujeitos à disponibilidade. / Ognuno in vendita separatamente secondo disponibilità. / Alle Artikel separat erhältlich. Einige Artikel werden nicht in allen Ländern vertrieben. / Sprzedawane oddzielnie w zależności od dostępności. / Per stuk verkrijgbaar en niet overal leverbaar. / Каждый продукт продается отдельно, в зависимости от наличия. / Sælges separat og så længe lager haves. / Alla delar säljs separat så långt lagret räcker. / Hver leke selges separat så langt lageret rekker. / Jokainen myydään erikseen, saatavuus voi vaihdella. / Το καθένα πωλείται ξεχωριστά και ανάλογα με τη διαθεσιμότητα. / Her biri ayrı ayrı ve stoklara bağlı olarak satılır. / 每件单独出售，并且视库存情况而定。 / それぞれ在庫状況に従って個別に販売されます。 / تباع كل منها على حدة وتخضع لتوفرها. / 1186 MJ, 1, NL

©2018, MEGA Brands Inc. & ™ MEGA Brands Inc. CONSTRUX™ is owned by Mattel and used under license. CONSTRUX™ appartient à Mattel et est utilisée sous licence. Printed in Canada D-GCP90-01

MEGA Brands Inc. Montreal QC H4T 1K4 Canada
MADE IN CANADA WITH DOMESTIC AND IMPORTED COMPONENTS.
FABRIQUÉ AU CANADA AVEC DES COMPOSANTS DOMESTIQUES ET IMPORTÉS.
FABRICADO EN CANADÁ CON COMPONENTES CANADIANOS E IMPORTADOS.
FABRICADO EN CANADÁ CON PIEZAS FABRICADAS EN CANADÁ Y PIEZAS IMPORTADAS.

* Visit megaconstrux.com/apps for complete list of compatible devices / Visitez megaconstrux.com/apps pour voir la liste complète des appareils compatibles / Eine vollständige Liste der kompatiblen Geräte finden Sie auf megaconstrux.com/apps / Visita megaconstrux.com/apps per consultare la lista completa di dispositivi compatibili / Ga naar megaconstrux.com/apps voor een volledige lijst van compatibele apparaten / Consultar la lista completa de dispositivos compatibles en: megaconstrux.com/apps / Visite megaconstrux.com/apps para obter a lista completa de dispositivos compatíveis / Επισκεφτείτε το megaconstrux.com/apps για μια πλήρη λίστα των συμβατών συσκευών / Полный список совместимых устройств см. на сайте megaconstrux.com/apps / Uyumlu cihazların tam listesini için megaconstrux.com/apps adresini ziyaret edin / Odwiedź stronę megaconstrux.com/apps, aby przejrzeć listę obsługiwanych urządzeń / قومي بزيارة megaconstrux.com/app للحصول على قائمة كاملة لجميع الأجهزة المتوافقة



megaconstrux.com