

**MEGA**<sup>™</sup>  
**CONSTRUX**

**MASTERS**  
OF THE UNIVERSE<sup>™</sup>



**PRO**  
**BUILDERS**<sup>™</sup>  
GPH24

**PANTHOR** AT / AU EN / NO **POINT DREAD**

**1**

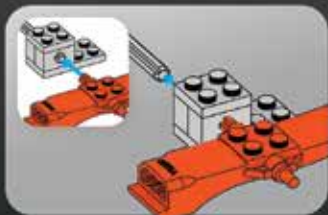

### Building Tool Outil de construction

Herramienta de construcción  
Bauwerkzeug  
Ferramenta de montagem  
Инструмент для конструирования

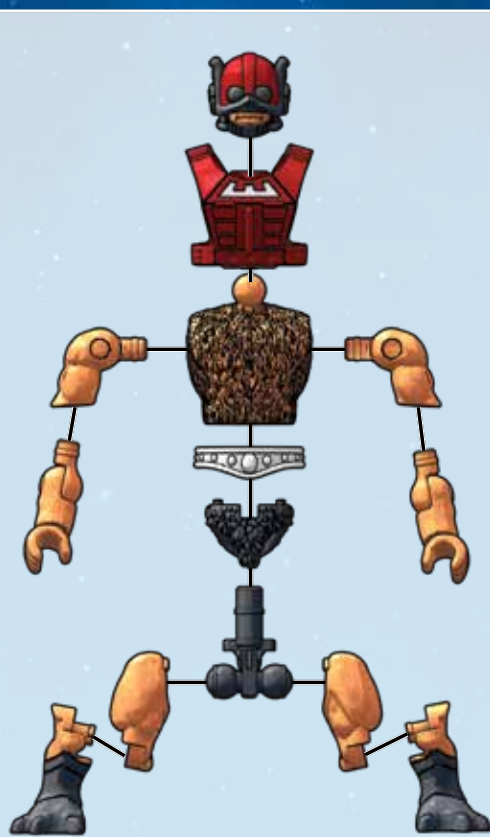
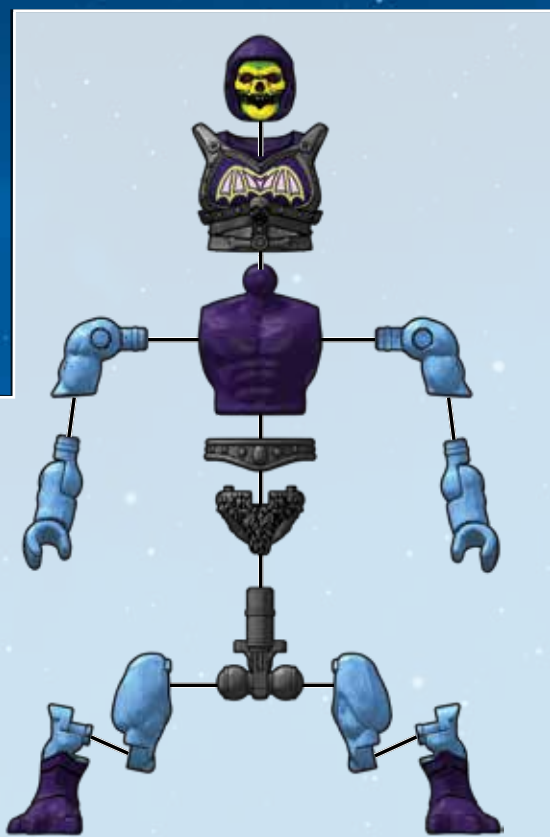
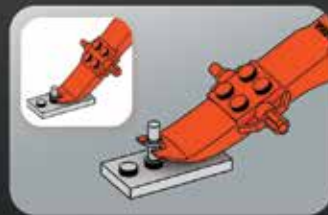
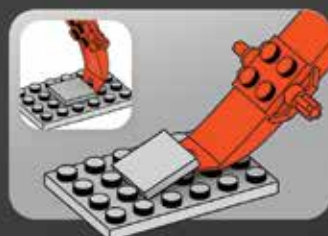

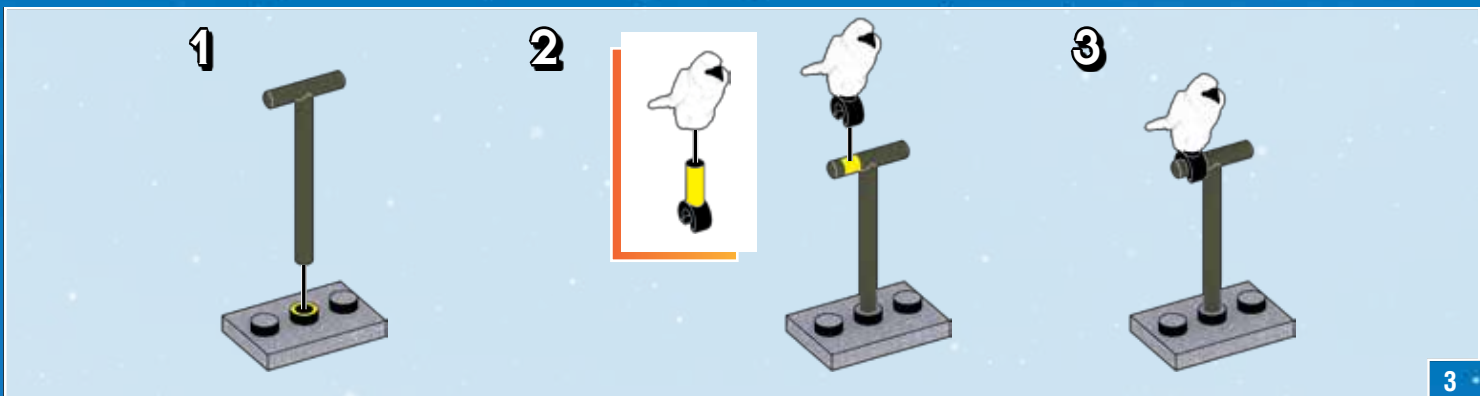
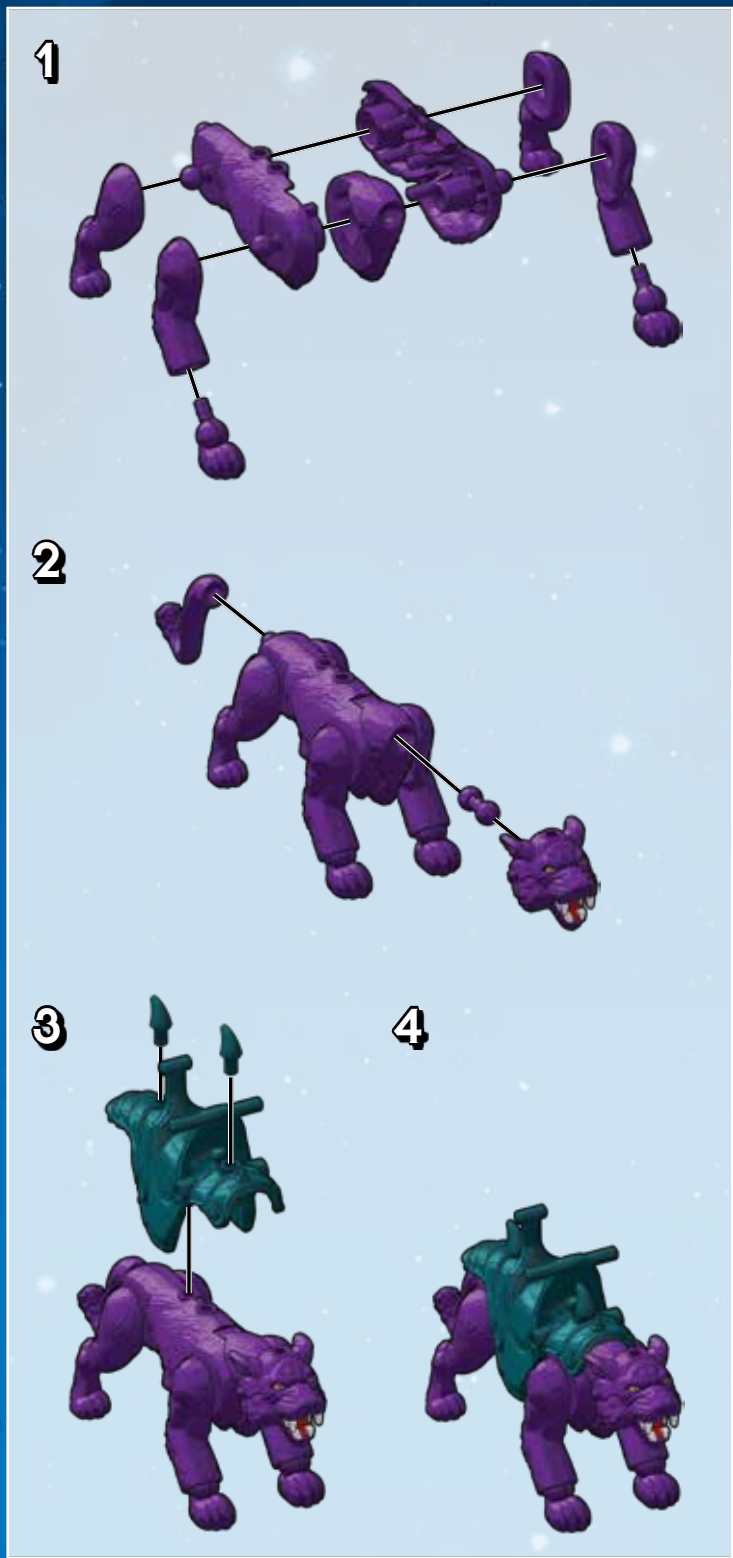
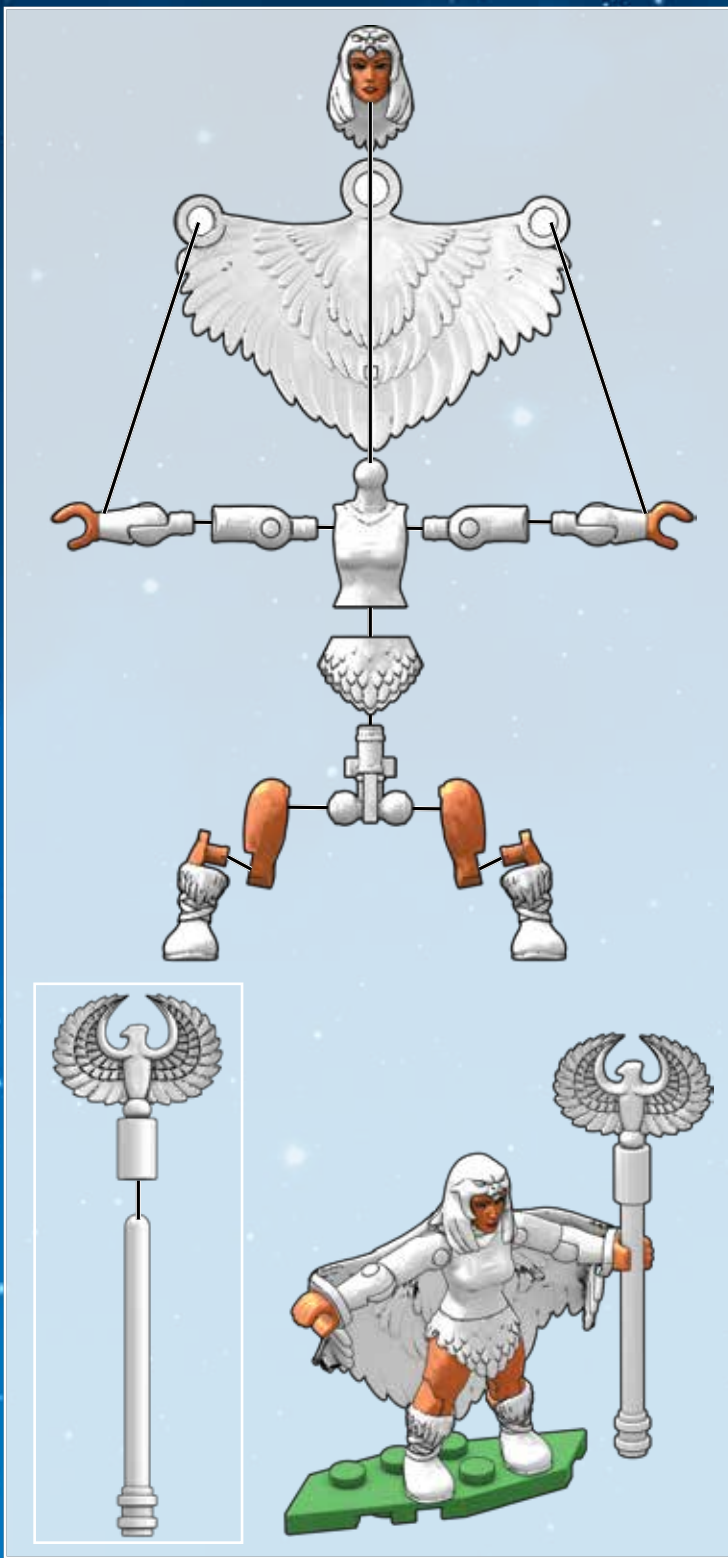

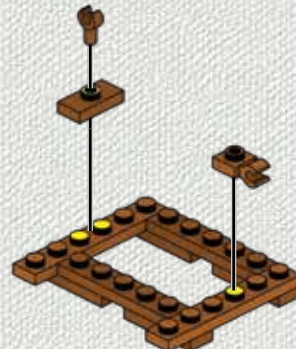
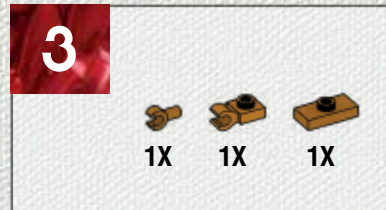
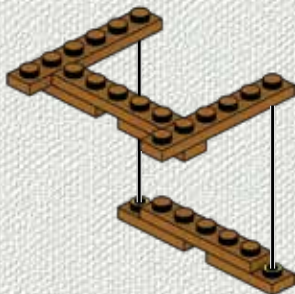
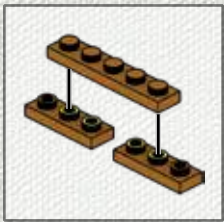
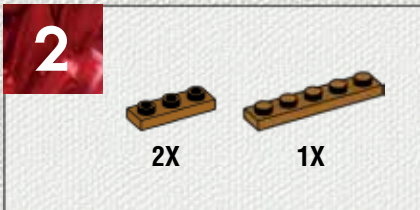
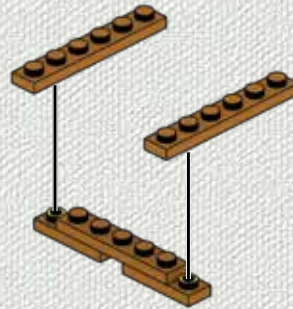
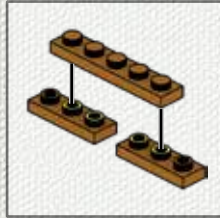
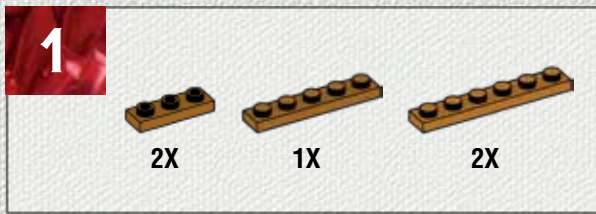
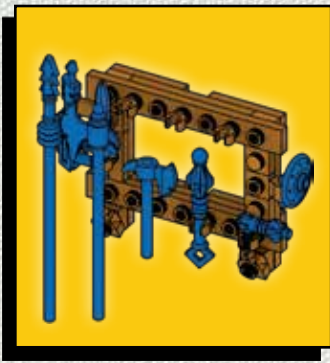

**4**

2X 1X

**5**

2X 2X

**6**

2X 1X

x2

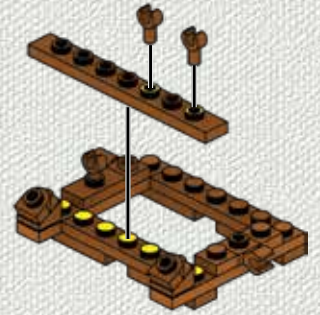
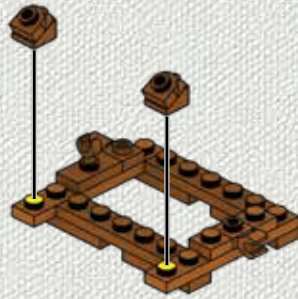
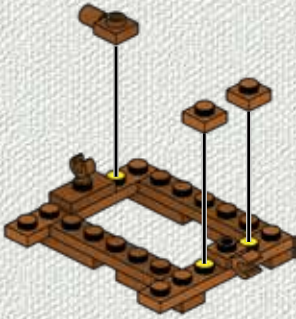

**7**

3X 1X

**8**

2X

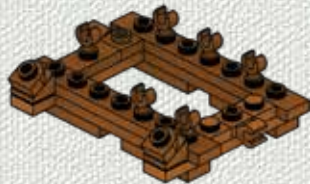
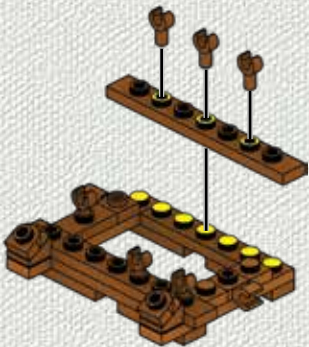

1

2

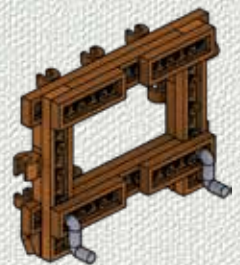
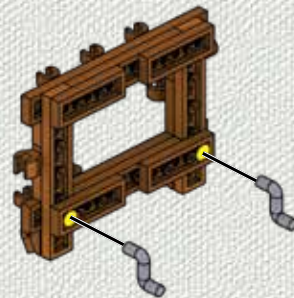

1

2

**9**

1X 1X 1X

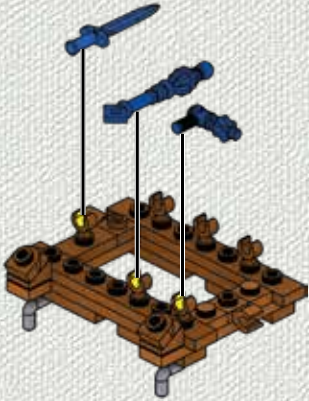

**10**

1X 1X

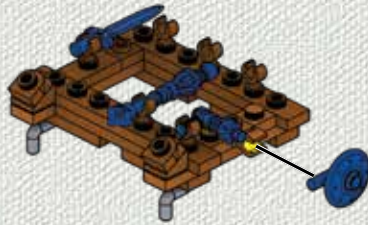
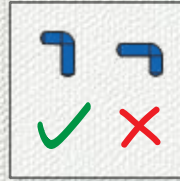
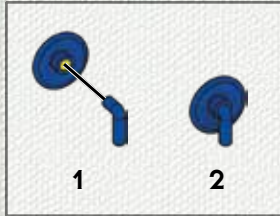

**11**

1X 1X

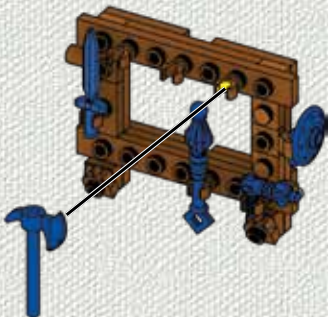
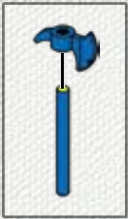

**12**

1X 1X

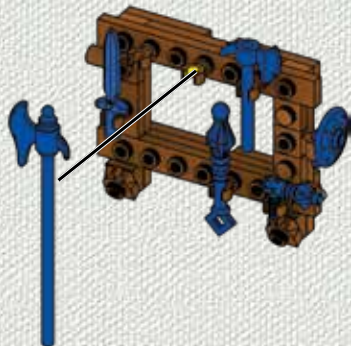
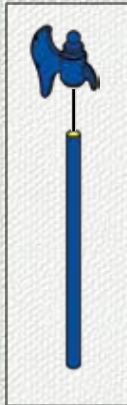

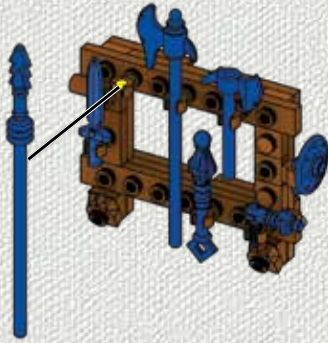
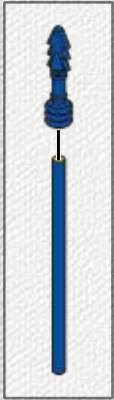
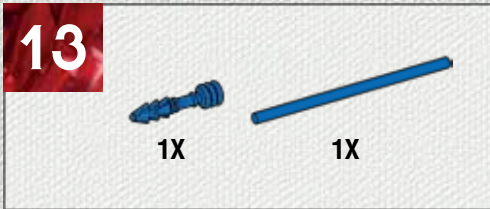

1

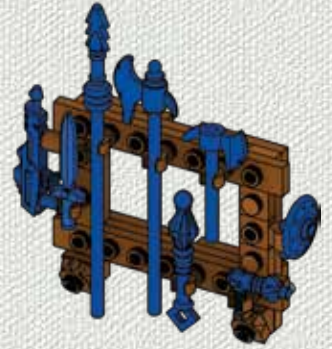

2

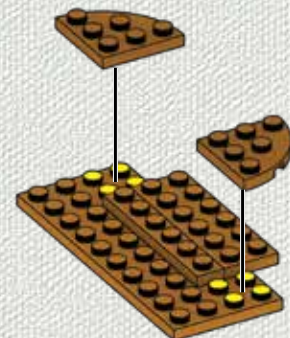
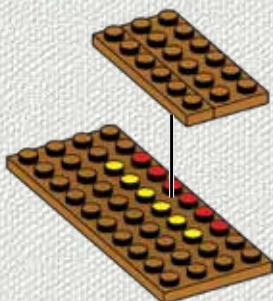
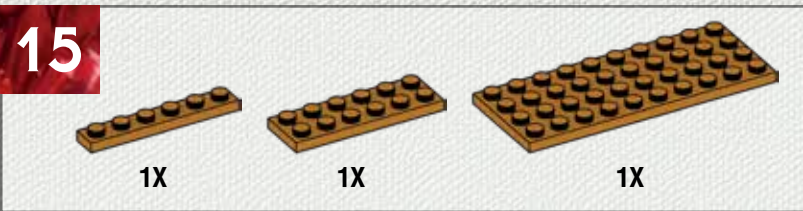
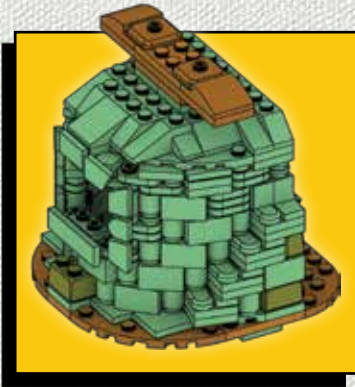

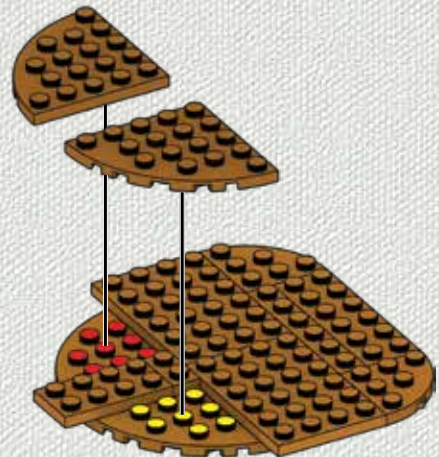
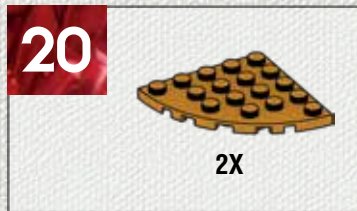
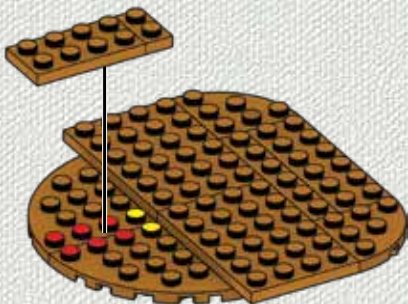
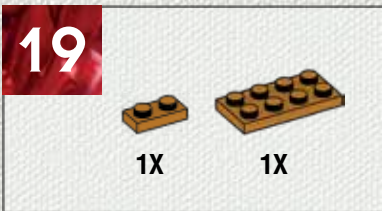
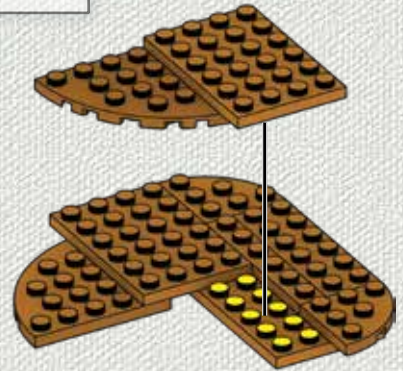
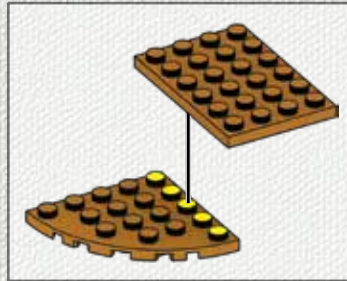
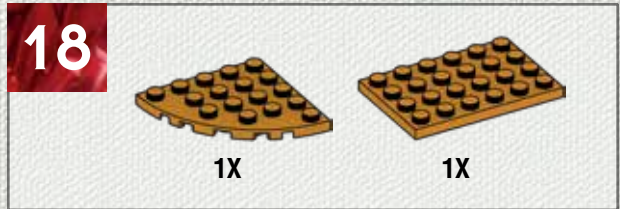
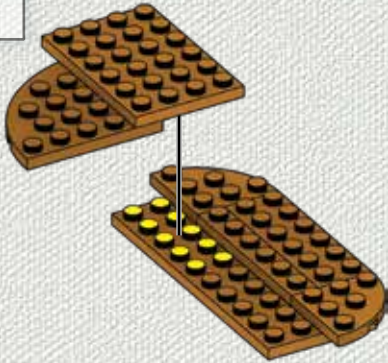
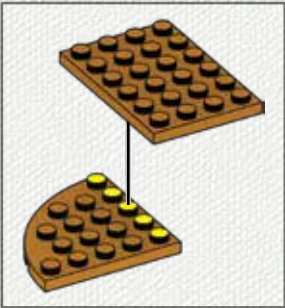
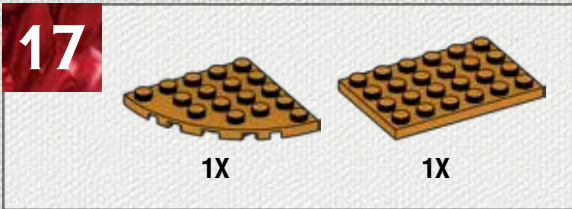

**21**

1X 1X 1X

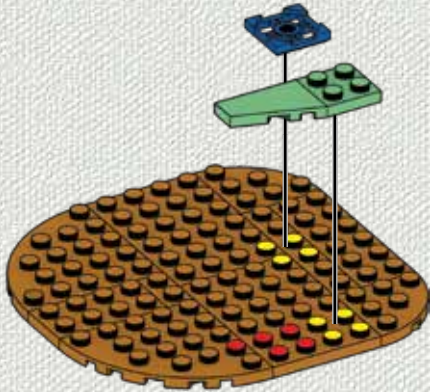

**22**

2X

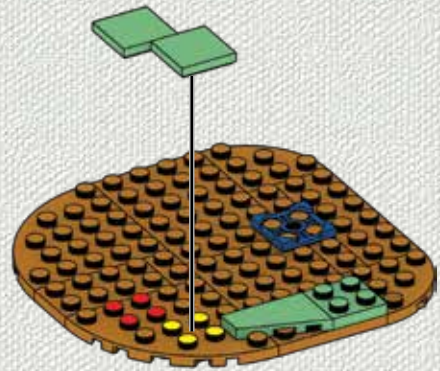

**23**

1X 1X

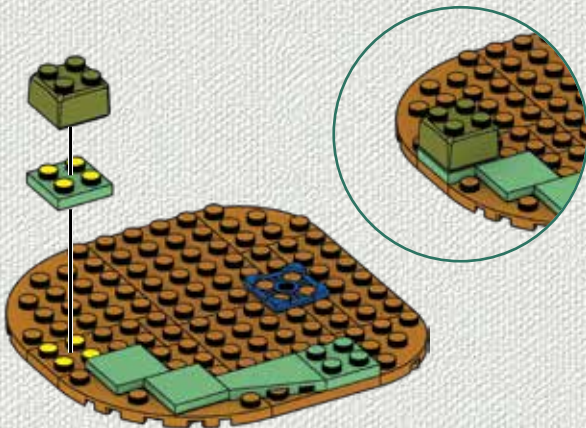

**24**

2X

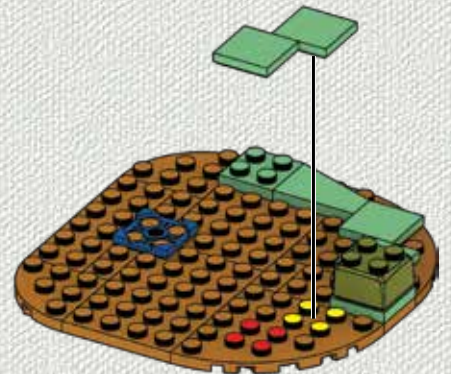

25



1X

1X

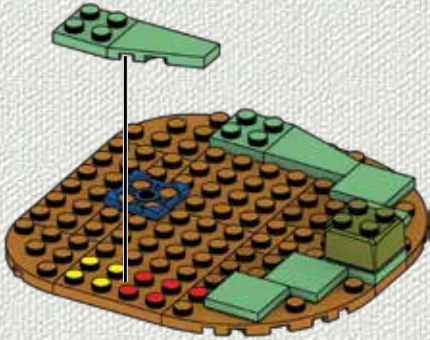

26



1X

1X

1X

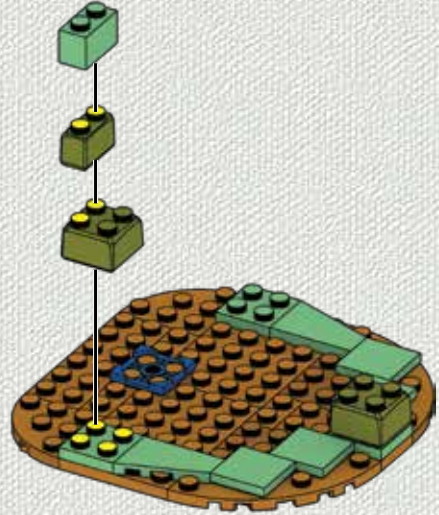

27



2X

1X

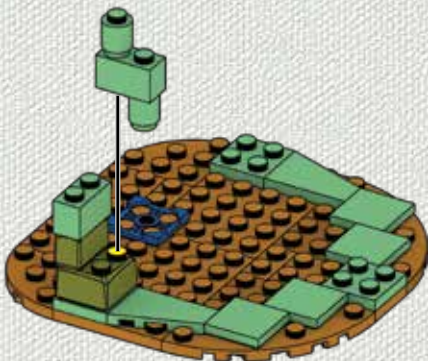
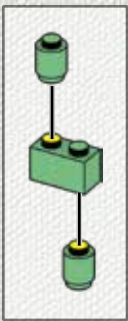

28



1X

2X

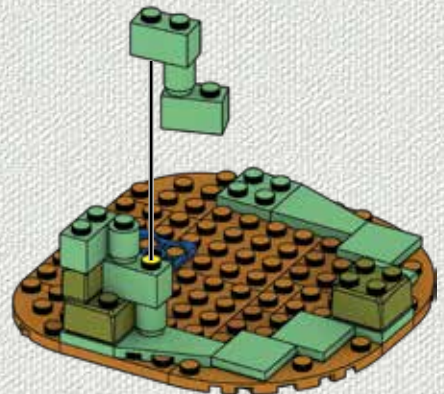
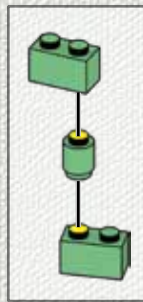

**29**

2X 1X

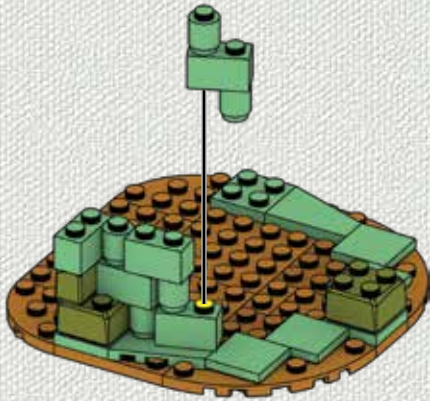
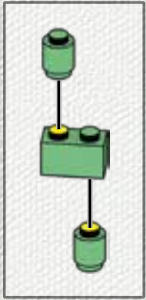

**30**

1X 2X

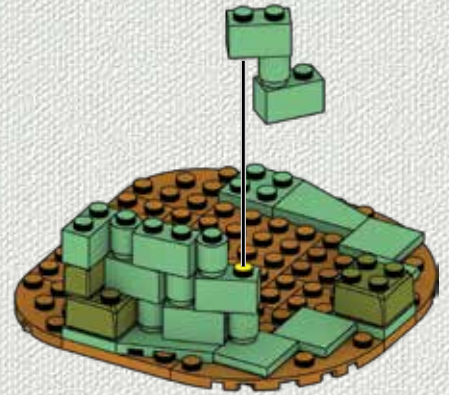
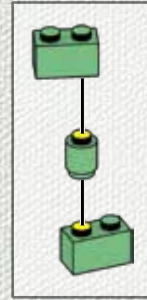

**31**

1X 1X 1X 1X

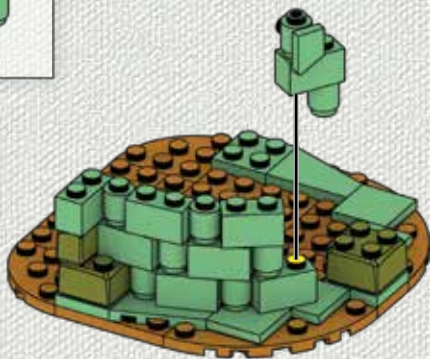
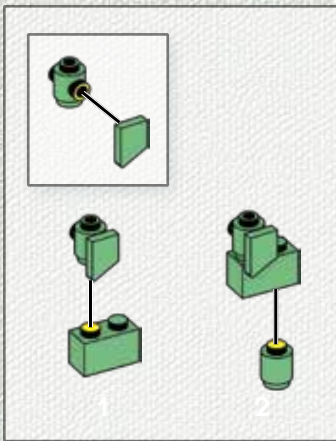

**32**

1X 1X

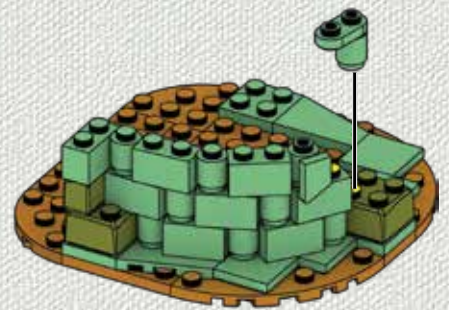
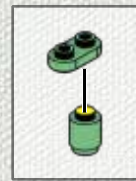

1



2

33

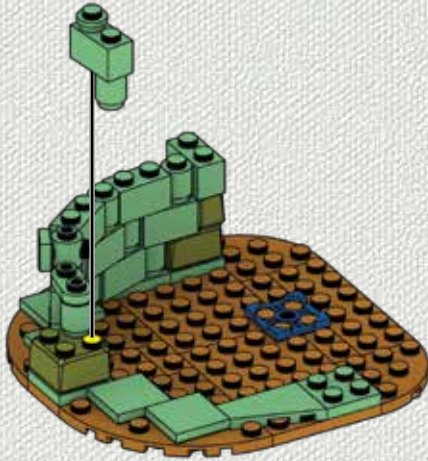
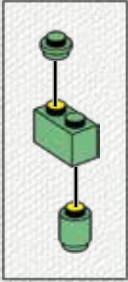
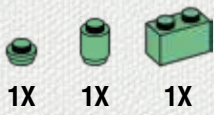

34

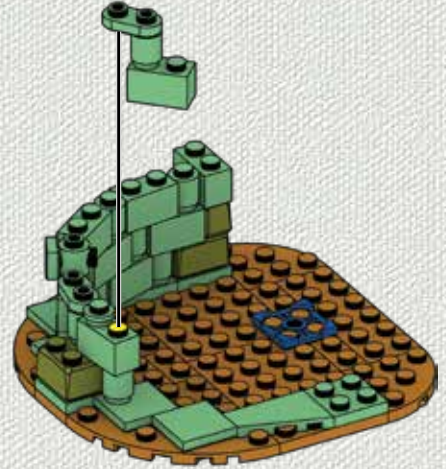
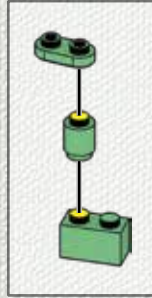
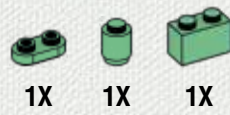

35

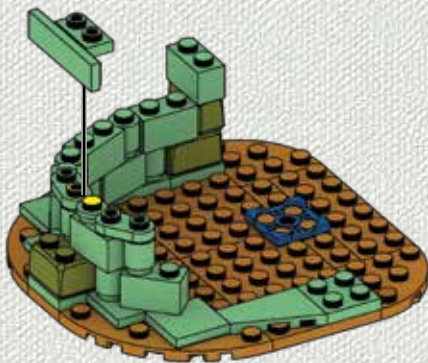
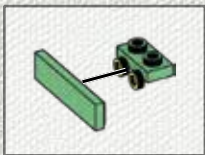

36

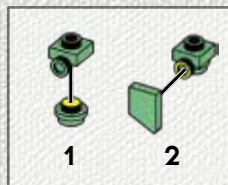

**37**

2X 1X

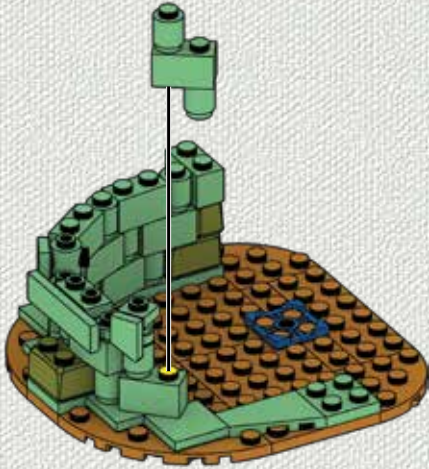
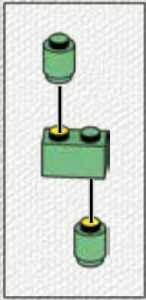

**38**

1X 1X 1X 1X 2X

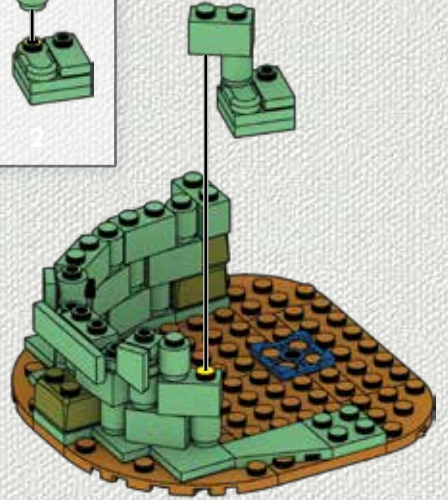
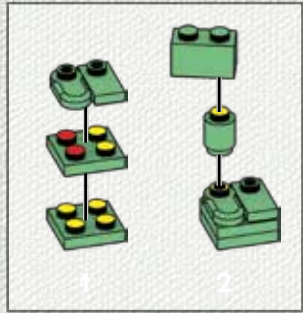

**39**

2X 1X 1X 2X

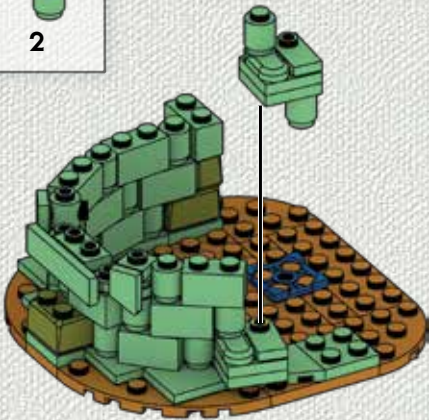
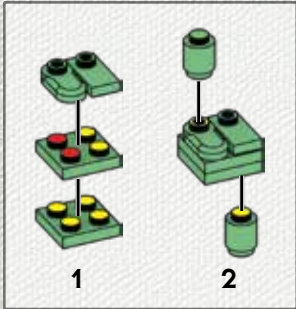

**40**

1X 1X

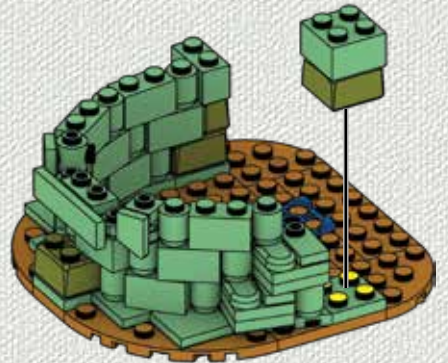
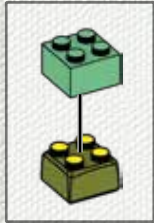

41

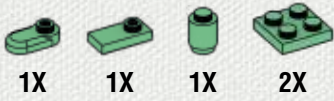

1X 1X 1X 2X

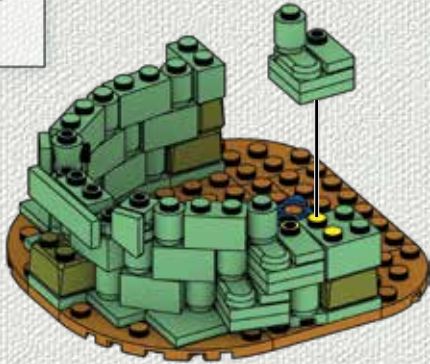
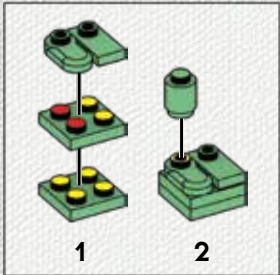

42



1X

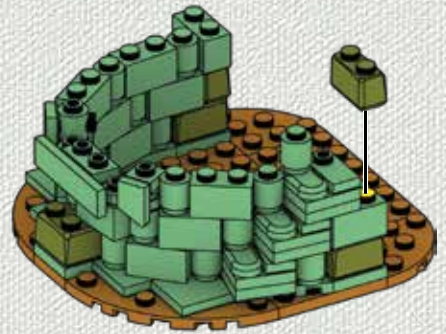

43



1X 1X 2X

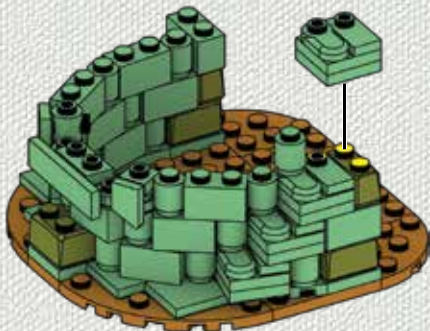
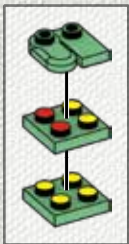

44



1X 1X

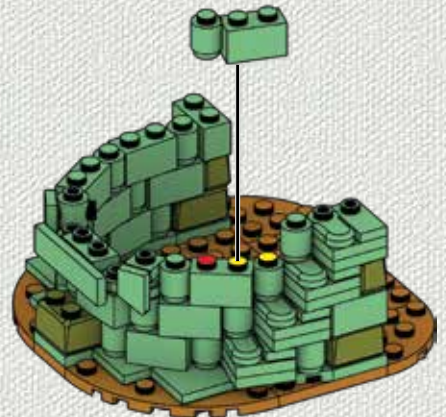

**45**

1X 1X 1X 2X

1 2

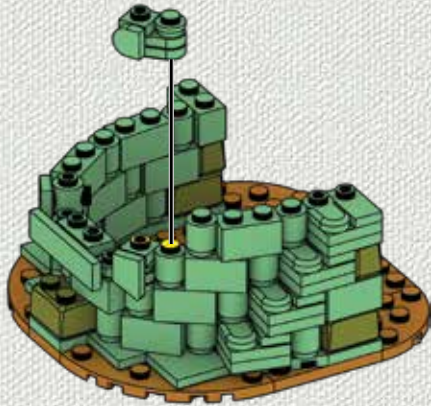

1

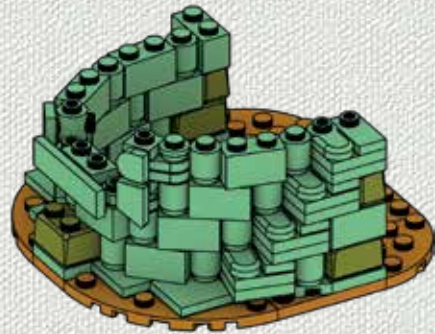

2

**46**

1X 1X 1X 2X

1 2

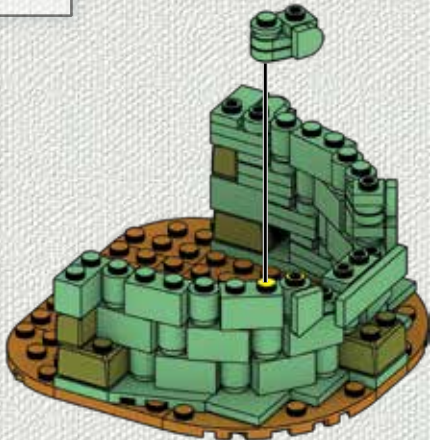

**47**

1X 1X

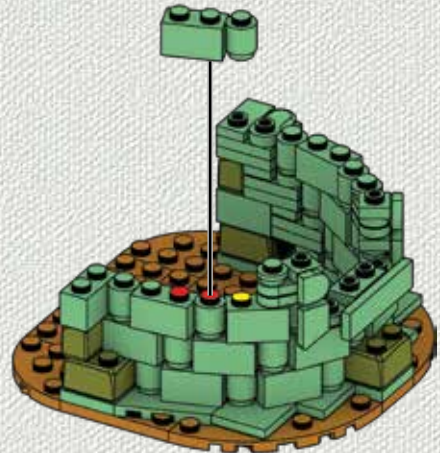

48



1X



1X

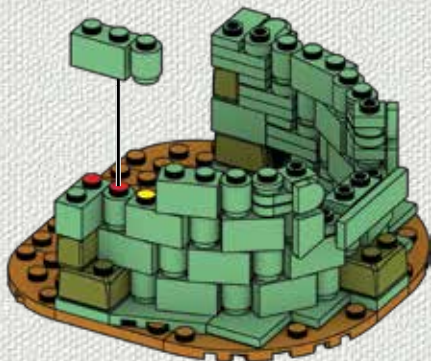

1

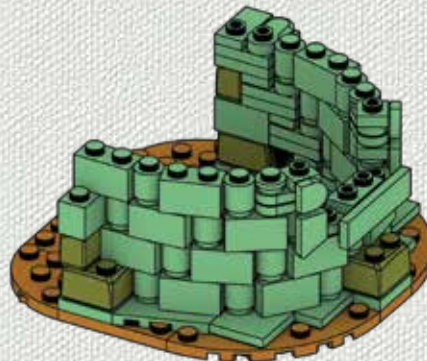

2

49



1X



1X



1X



50



2X



1



2

51

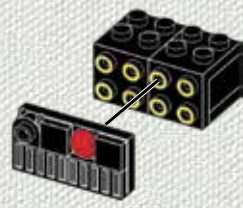
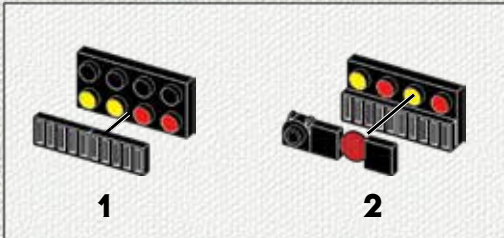

52

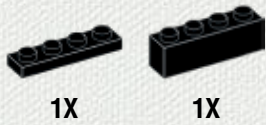

53

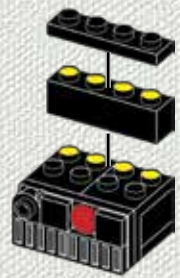

1

2

**54**



1X

**55**



2X      1X

**56**



2X      1X      1X



**57**



1X      1X

**58**



2X

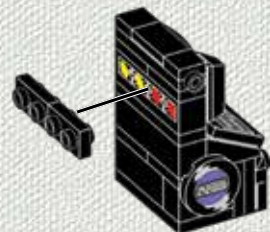
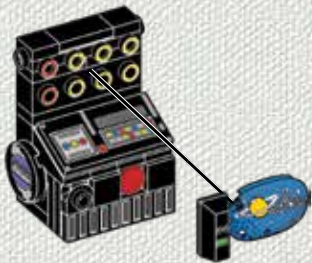

1

2

59



3X

60



1X

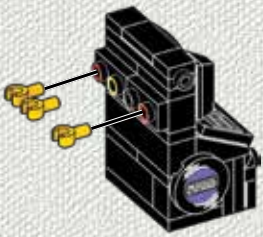

1



2



1



2

61

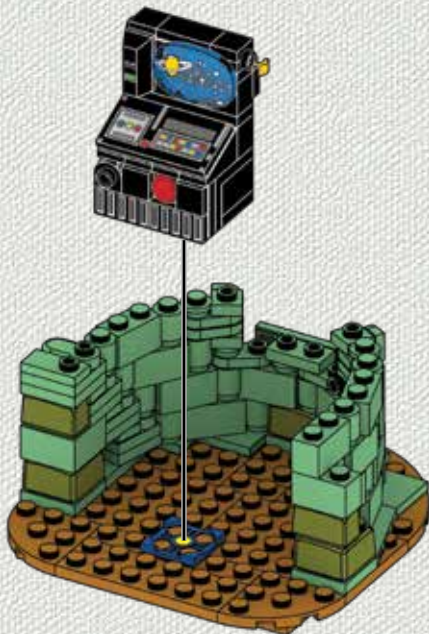

1

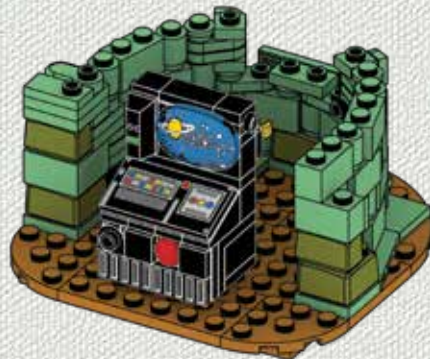

2



**62**

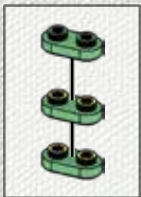

3X





**63**

1X 1X





**64**

1X 1X

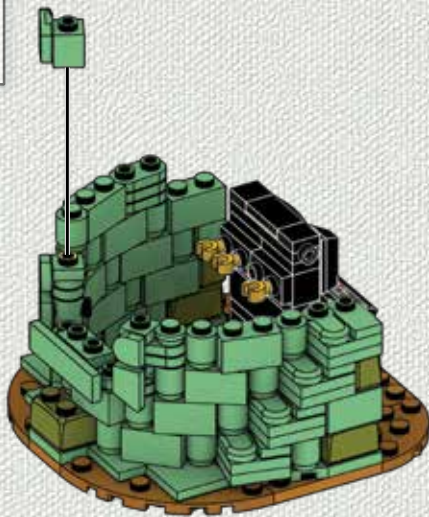
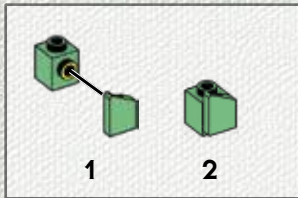

**65**

1X 1X

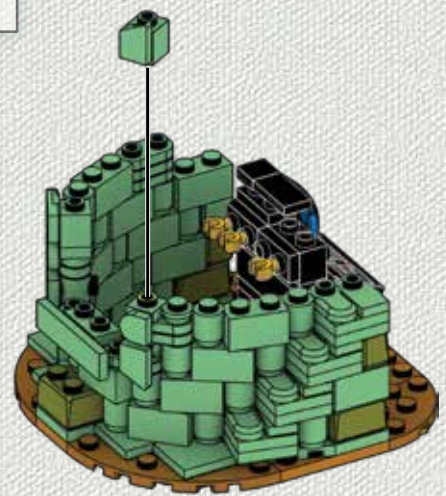
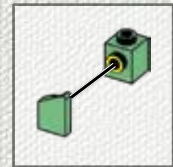

66

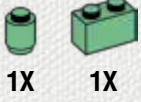

1X

1X



67



3X

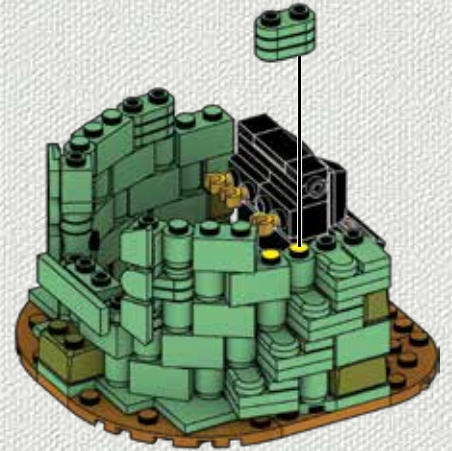
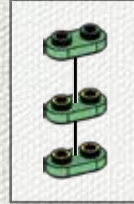

68



2X

4X

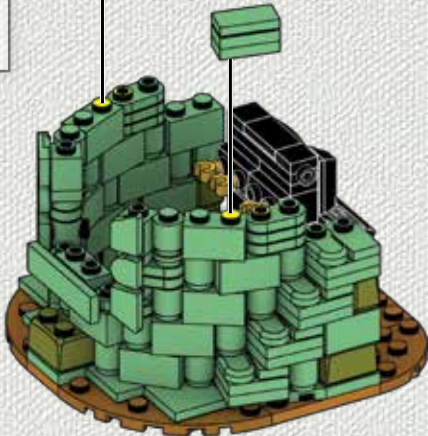
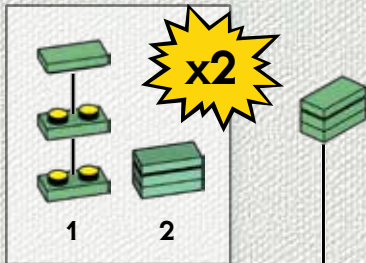

69



1X

3X

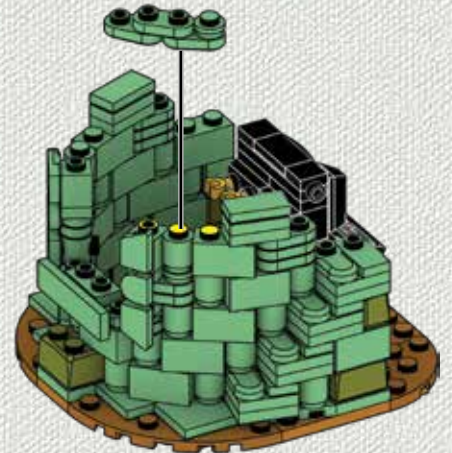
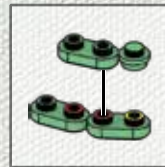

70

1X 3X

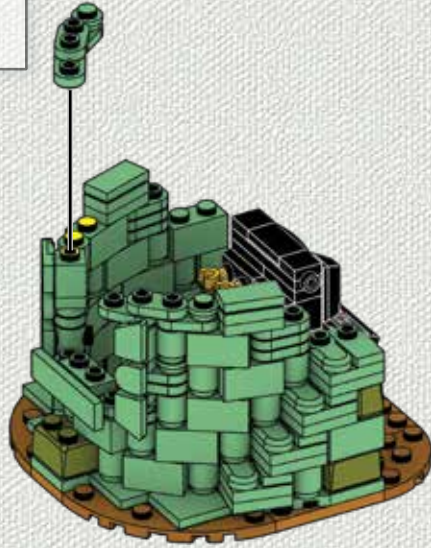
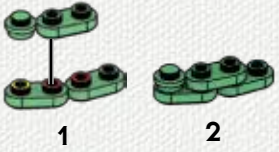

71

1X 1X



72

4X

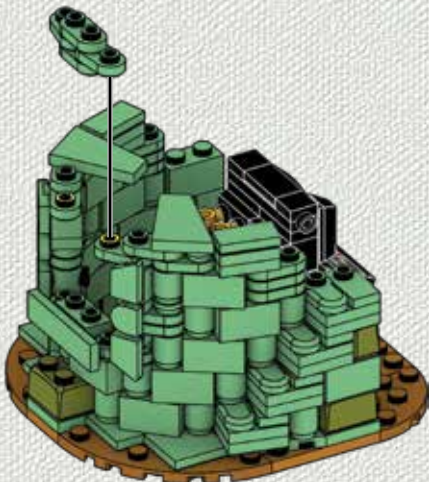
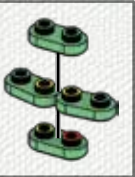

73

2X

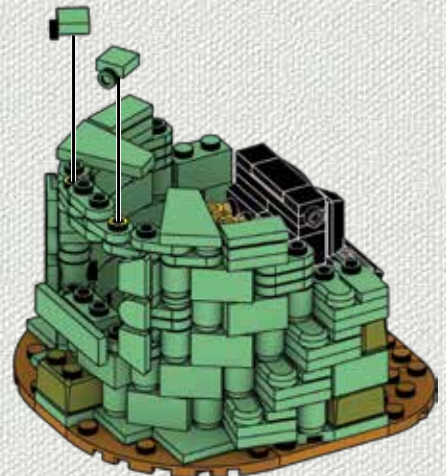

**74**

1X 1X

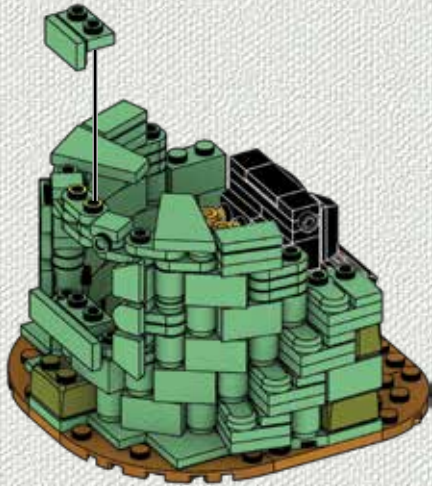
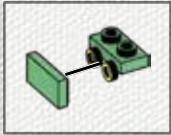

**75**

1X 1X

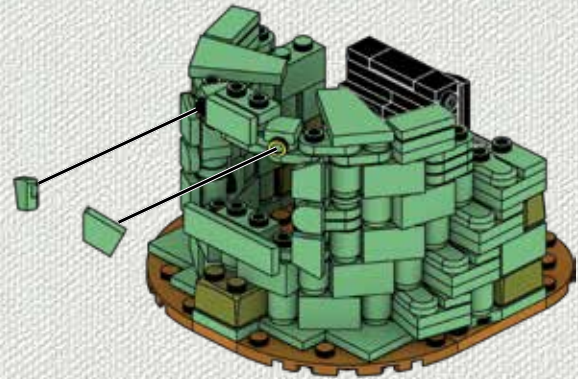
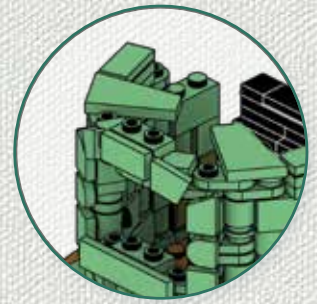

**76**

1X 2X

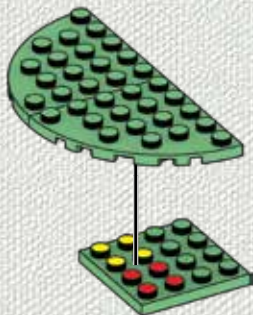

**77**

1X

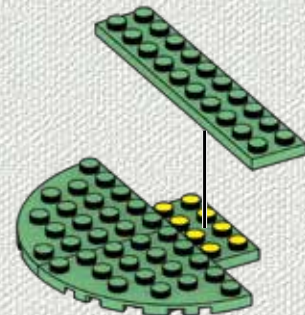

78

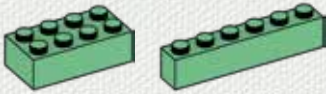

2X

1X

79



1X

1X

1X

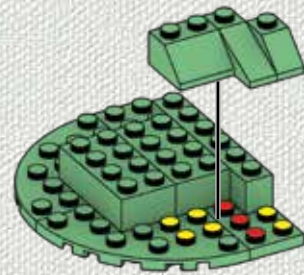
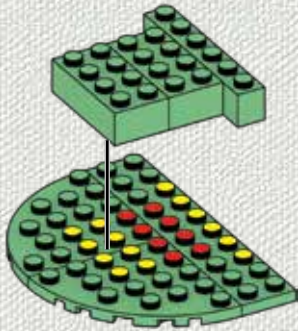

80



1X

1X

81



2X

1X

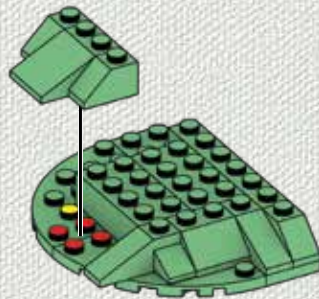

1



2

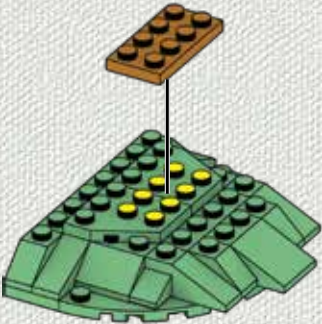
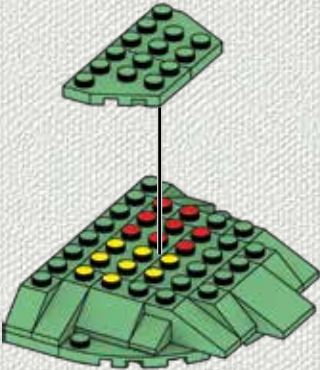
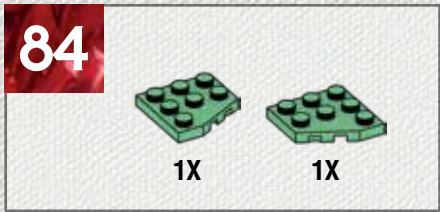
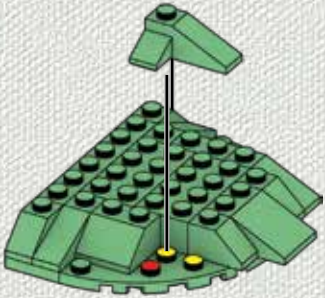
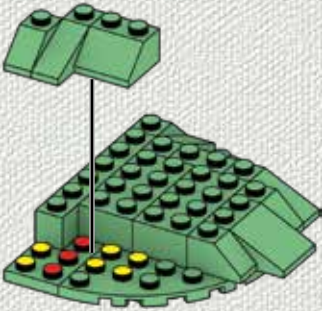
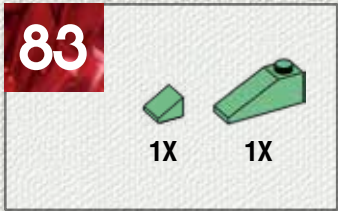
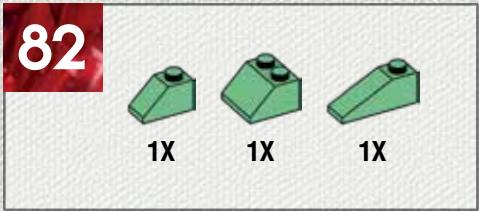

86

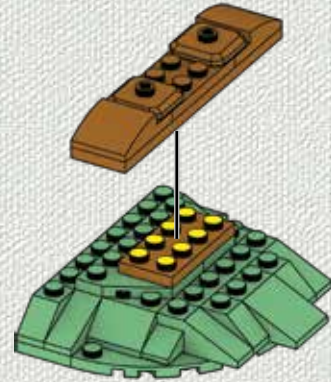
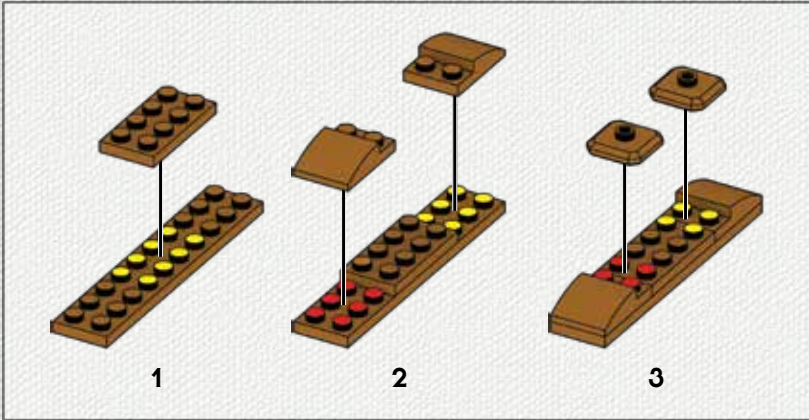

87

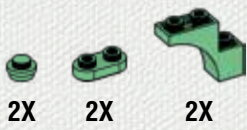

88

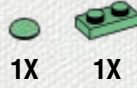

89

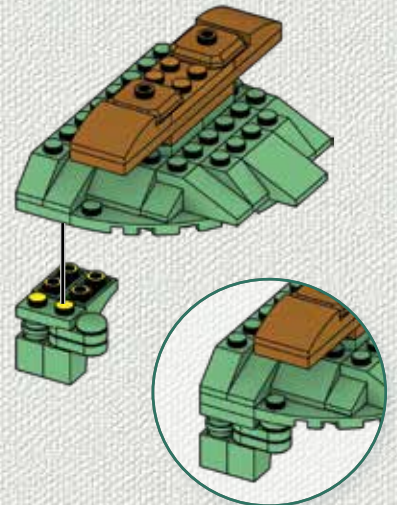
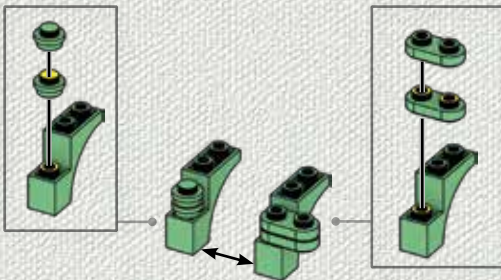

**90**

2X    2X    2X

**91**

1X    1X

**92**

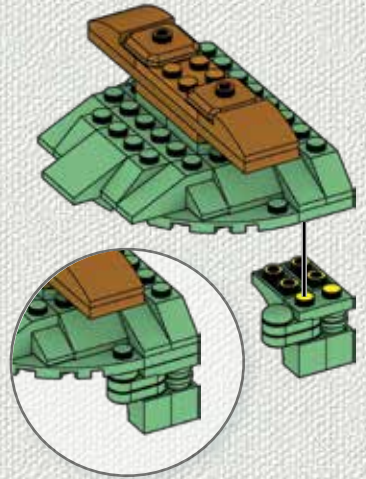
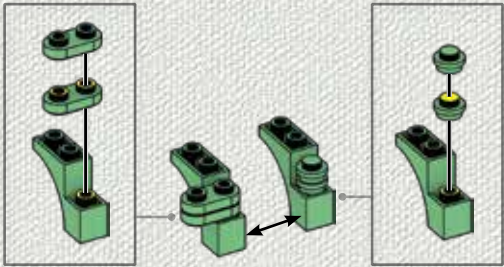

**93**

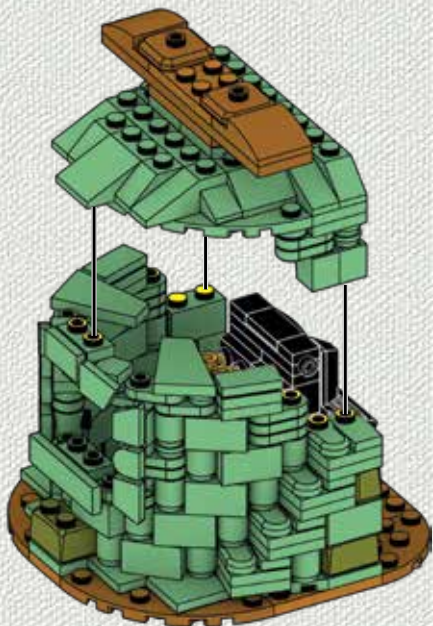

1

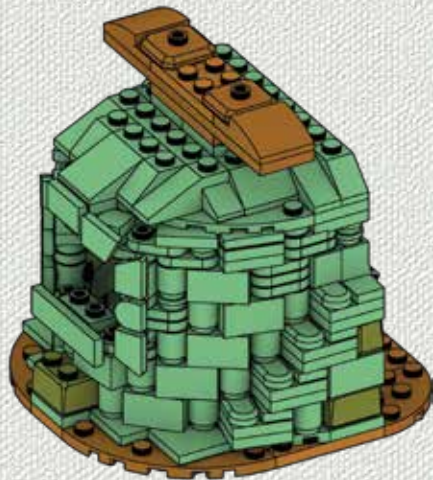

2



**94**

1X                      1X

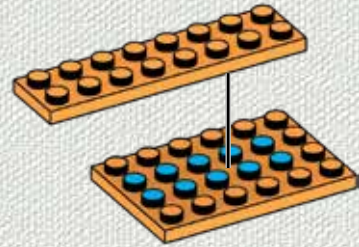

**95**

1X  
1X

**96**

2X

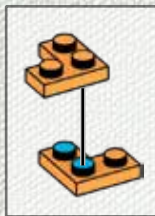

**97**

2X

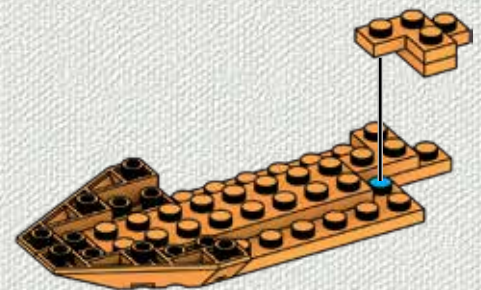
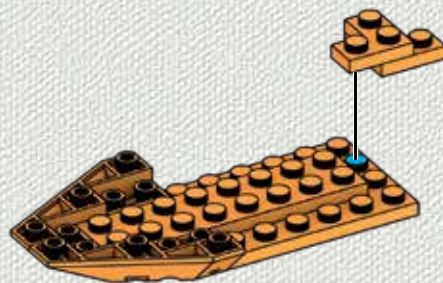
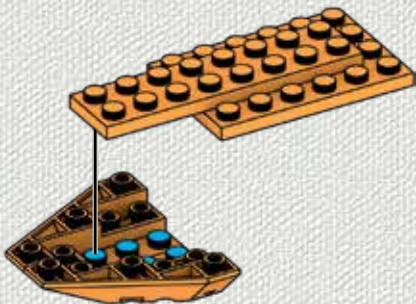
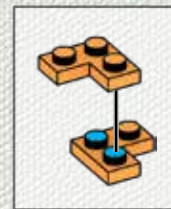

**98**



2X    1X

**99**



2X    1X

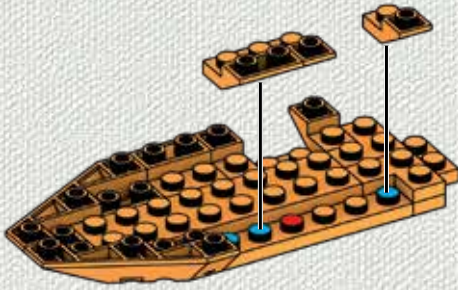
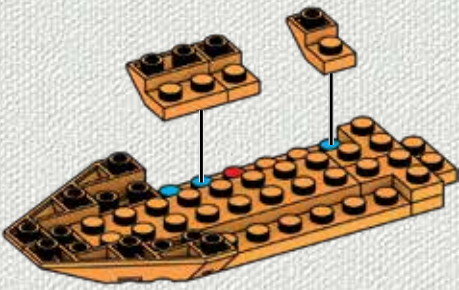

**100**



2X    2X

**101**



1X    1X

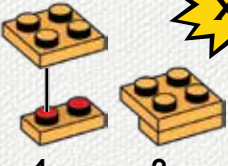

1    2

**x2**

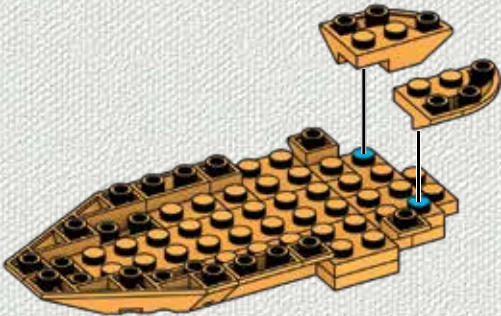
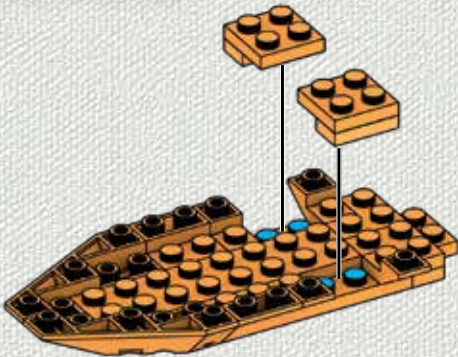

**102**



1X      1X

**103**



2X

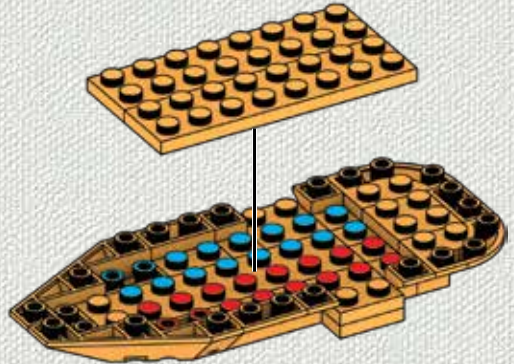
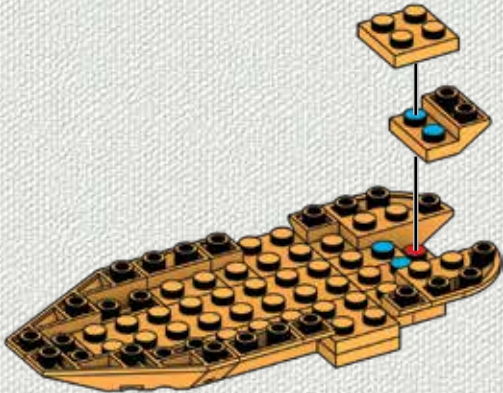

**104**



1X

**105**



3X

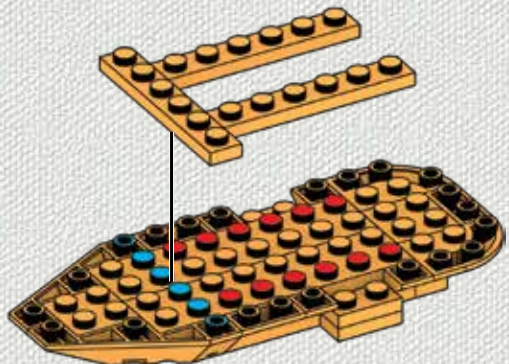
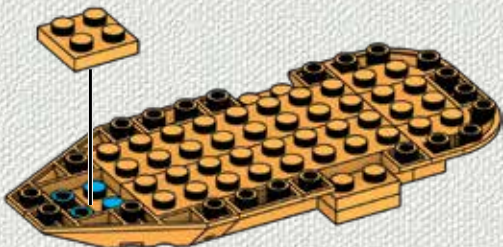

106

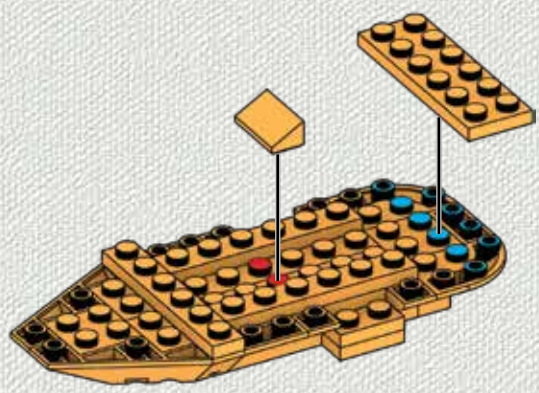
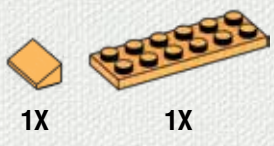

107

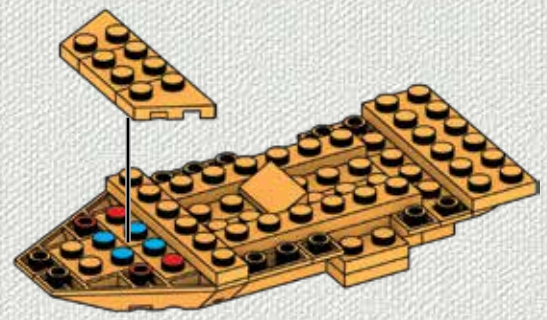
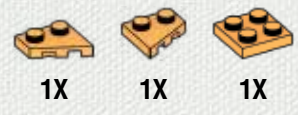

108

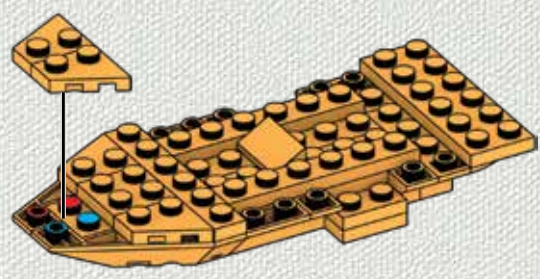

1

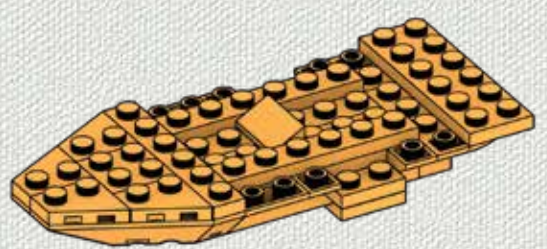

2

MEGA™  
CONSTRUX

MASTERS  
OF THE UNIVERSE™

MORE TO COLLECT! / ENCORE PLUS À COLLECTIONNER!  
¡MÁS PARA COLECCIONAR! / MAIS PARA COLECCIONAR!  
MEHR ZUM SAMMELN! / СОБЕРИ БОЛЬШЕ!



GPH23

Set(s) sold separately and subject to availability. / Ensemble(s) vendu(s) séparément. Certains produits peuvent ne pas être commercialisés. / Se vende(n) por separado y está(n) sujeto(s) a disponibilidad. / Conjunto(s) vendido(s) em separado e sujeito(s) à disponibilidade. / Set in vendita separatamente, secondo disponibilità. / Das/Die Set(s) sind separat erhältlich. / Zestaw(y) sprzedawany(e) oddzielnie w zależności od dostępności. / Set(s) apart verkrijgbaar en afhankelijk van beschikbaarheid. / Набор(-ы) продаются отдельно, при наличии. / Sæt sælges separat og så længe lager haves. / Seten säljs separat så länge lagret räcker. / Settet/settene selges separat så langt lageret rekker. / Pakkaus/pakkaukset myydään erikseen, saatavuus voi vaihdella. / Το(α) σετ πωλούνται ξεχωριστά και ανάλογα με τη διαθεσιμότητα. / Setler ayrı olarak satılır ve stoklarla sınırlıdır. / Set (sety) se prodává (prodávají) samostatně dle aktuální nabídky. / Súprava/-y sa predáva(jú) samostatne a podľa dostupnosti. / A készlet(ek) külön kapható(k), az elérhetőség változhat. /

セツ商品は別売りになります。在庫状況は別途ご確認ください。 / ثباغ المجموعة أو المجموعات على حدة وتخضع لتوافرها. / 每套单独发售，按供货情况决定。

Panther a Point Dread / Panther am Point Dread/ Panther w Point Dread / Panther bij Point Dread  
Пантер в Point Dread / O Panther στο Point Dread/ Point Dread'de Panther / Panther Point Dreadnél/  
Panther vid Point Dread / Panther Pelkopisteessä/ Panther ved Point Dread / Panther na Point Dread/  
ديردن پونٹ پو روٹناب

MEGA Brands Inc. Montreal QC H4T 1K4 Canada

ASSEMBLED IN CANADA WITH DOMESTIC AND IMPORTED COMPONENTS. ASSEMBLÉ AU CANADA AVEC DES ÉLÉMENTS DOMESTIQUES ET IMPORTÉS. MONTADO NO CANADÁ COM COMPONENTES NACIONAIS E IMPORTADOS. MONTADO EN CANADÁ CON PIEZAS FABRICADAS EN CANADÁ Y PIEZAS IMPORTADAS. СБОРКА ВЫПОЛНЕНА В КАНАДЕ С ОТЕЧЕСТВЕННЫМИ И ИМПОРТНЫМИ КОМПОНЕНТАМИ. ИЗГОТОВЛЕНО В КИТАЕ. YERLİ VE İTHAL PARÇALARLA KANADA'DA MONTE EDİLMİŞTİR. صنع في كندا من مواد محلية ومستوردة.

© D714,887, D781,964, D797,203,  
D809,611, D835,727, D841,101

1186 MJ, 1, NL



©2020, MEGA Brands Inc. & MEGA Brands Inc. CONSTRUX™ is owned by Mattel and used under license. CONSTRUX™ appartient à Mattel et est utilisée sous licence. Printed in Canada / Imprimé au Canada D-GPH24-01

HE-MAN™, MASTERS OF THE UNIVERSE™ and associated trademarks and trade dress are owned by, and used under license from Mattel, Inc. ©2020 Mattel. All Rights Reserved.



BUILD & SHARE  
CONSTRUIRE ET PARTAGER  
CONSTRUYE Y COMPARTE | MONTAR E  
COMPARTILHAR | BAUEN UND MIT  
ANDEREN TEILEN | СОЗДАВАЙ И ДЕЛИСЬ

megaconstrux.com



MIX  
Paper from responsible sources  
Papier issu de sources responsables  
FSC® C011825

**MEGA**<sup>™</sup>  
**CONSTRUX**

**MASTERS**  
OF THE UNIVERSE<sup>™</sup>



**PRO**  
**BUILDERS**<sup>™</sup>  
GPH24

**PANTHOR** AT / AU EN / NO **POINT DREAD**

**2**



**111**  
1X



**112**  
4X

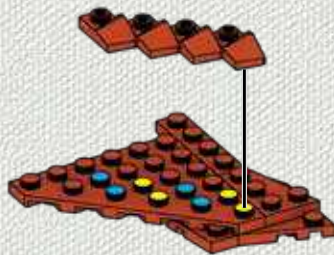

**113**  
3X



**114**  
3X



**115**

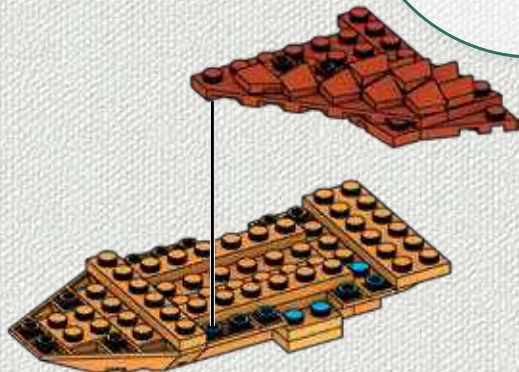
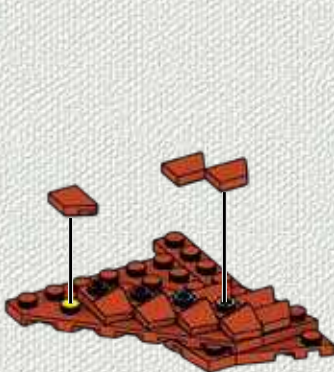
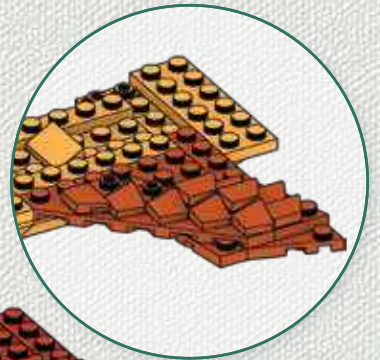

116



1X

1X

1X

117



1X

1X

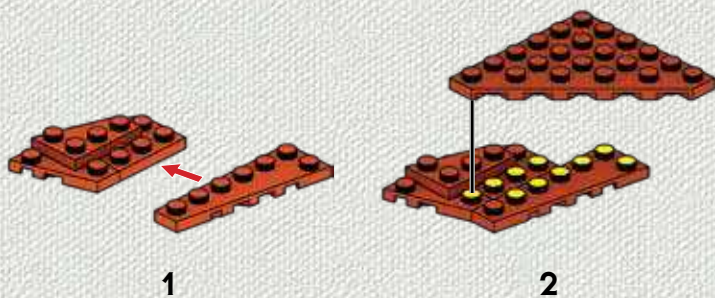

1

2

118



1X

119



4X

120



3X

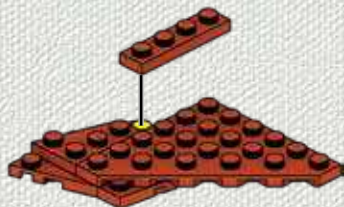

**121**



3X

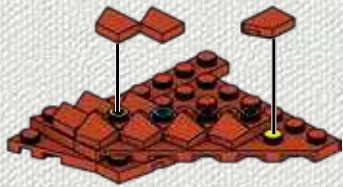

1



2

**122**

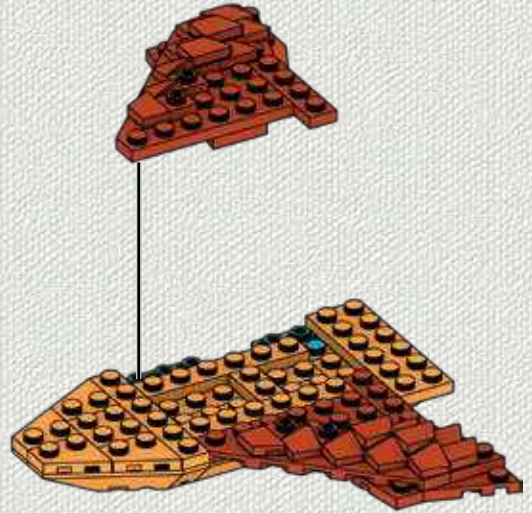

**123**



4X

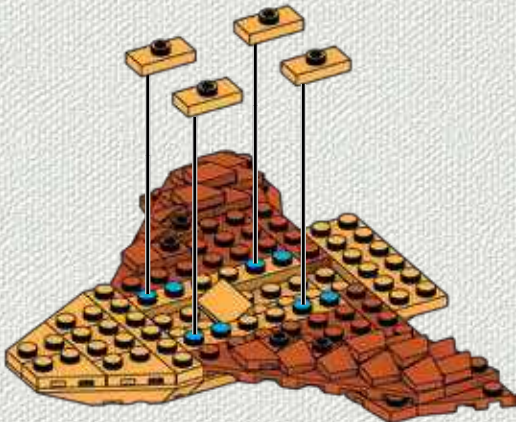

**124**



4X

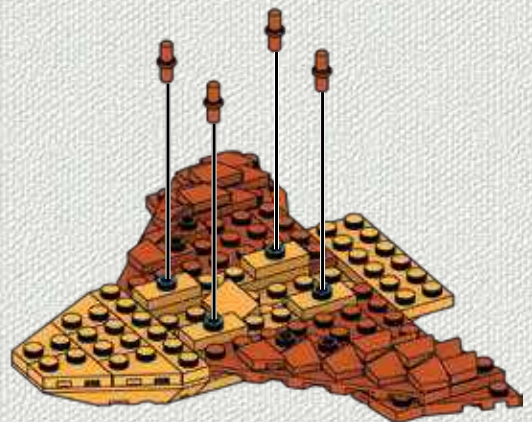

125



2X

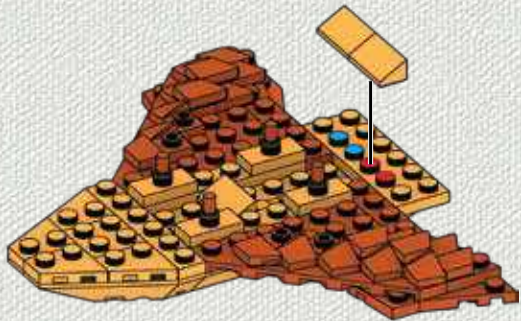

126



1X

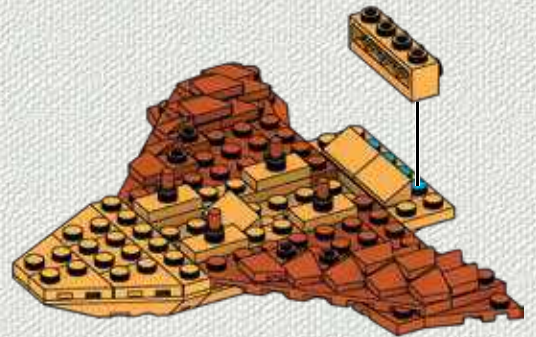

127



1X



1X

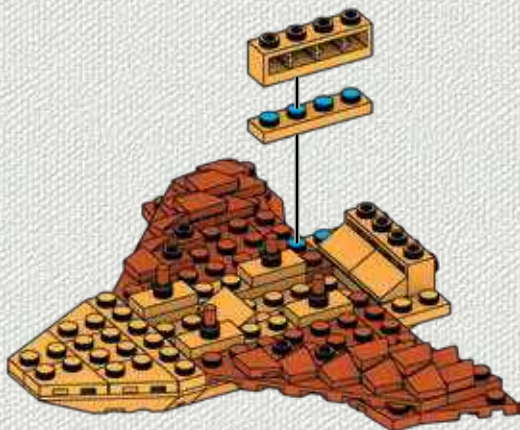

128



1X



1X

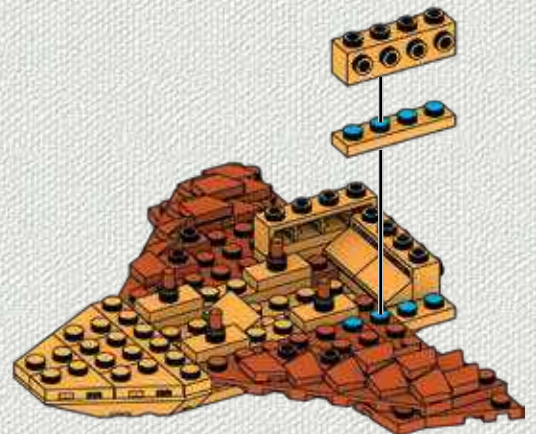

**129**



2X

**130**



2X

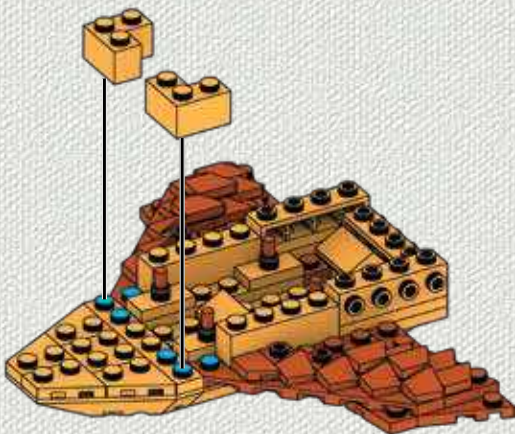
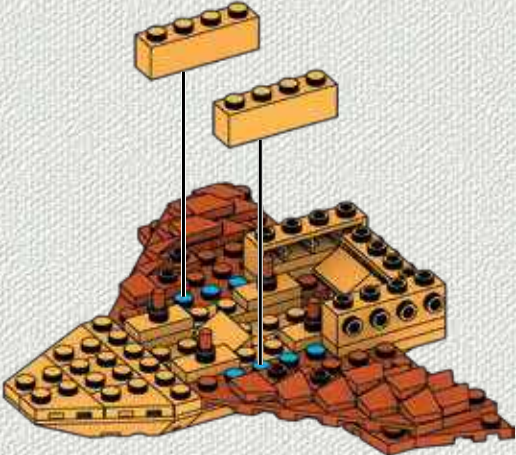

**131**



1X



1X



1X

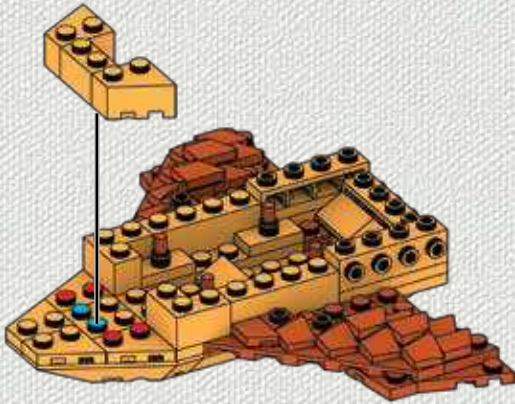

1

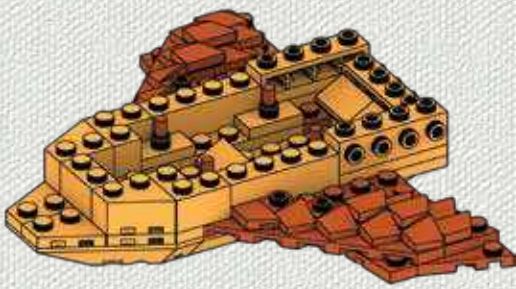

2



**132**

1X 1X 1X

**133**

1X 2X



**134**

1X 1X 1X

**135**

1X 1X 1X

**136**

1X

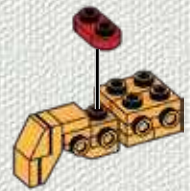
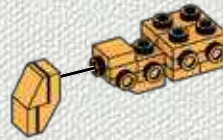
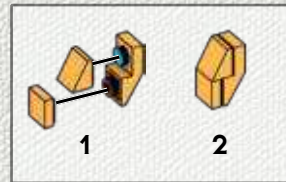
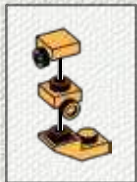

**137**



2X

**138**



2X 1X 1X

**139**



1X 1X 1X

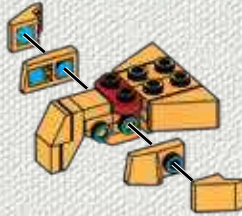

**140**



1X 1X 1X

**141**

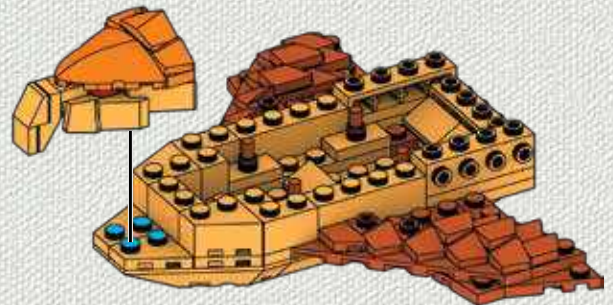

142



4X



143



1X

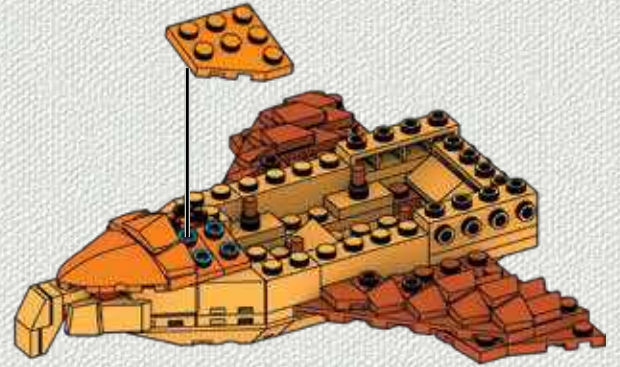
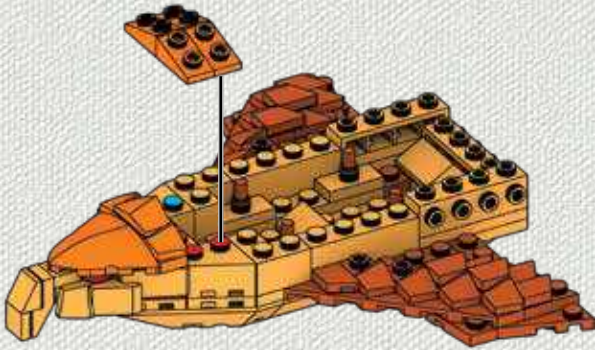

144



3X



1X

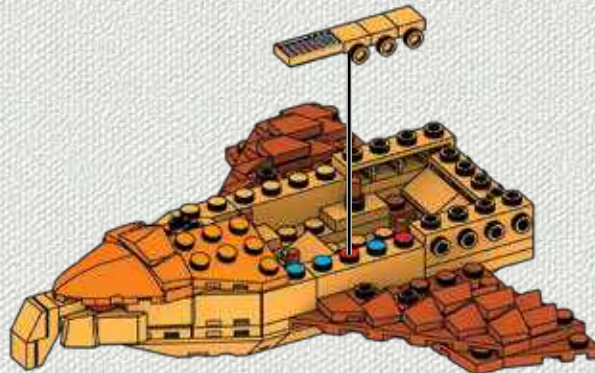

**145**



2X 1X 1X

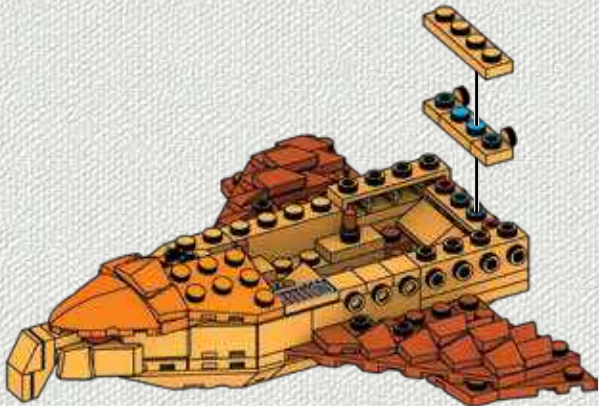

1

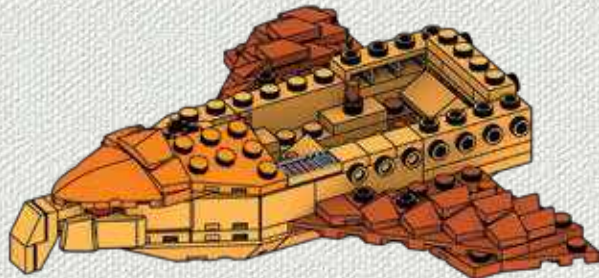

2

**146**



1X

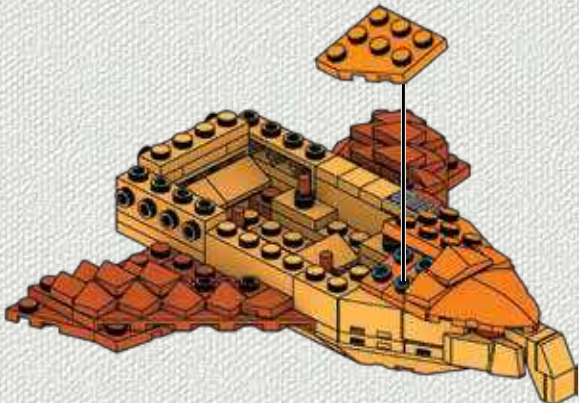

**147**



3X 1X



148



4X

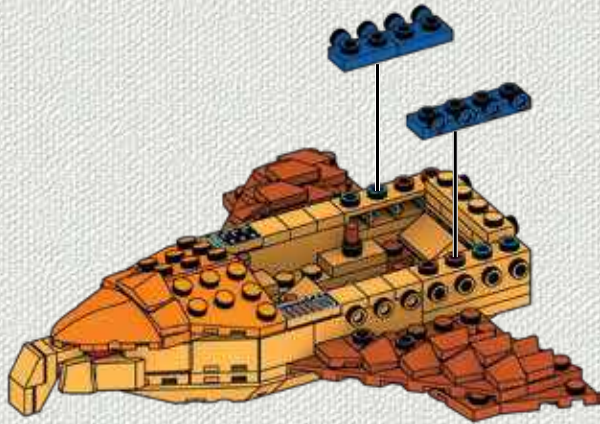

149



1X



2X

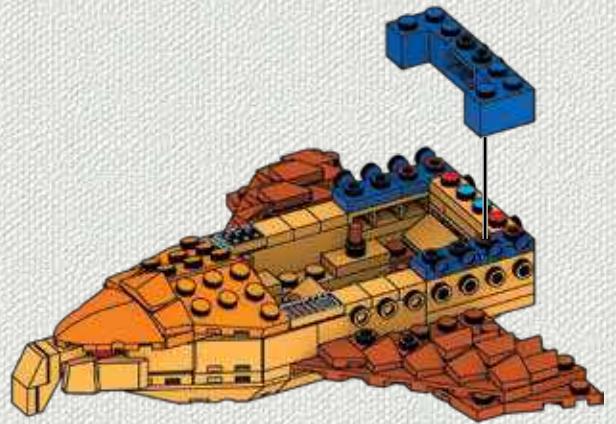

150



2X

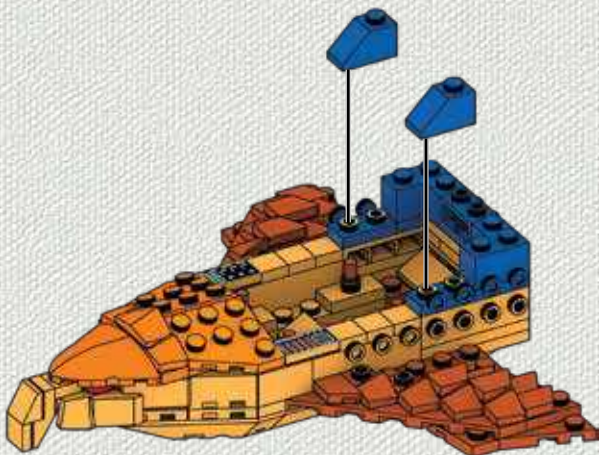

151



2X

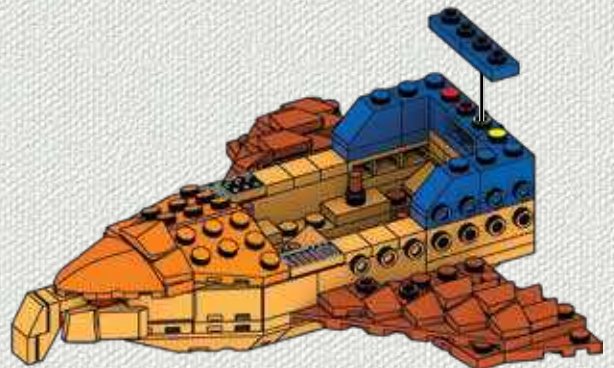

**152**



2X    1X

**153**



1X

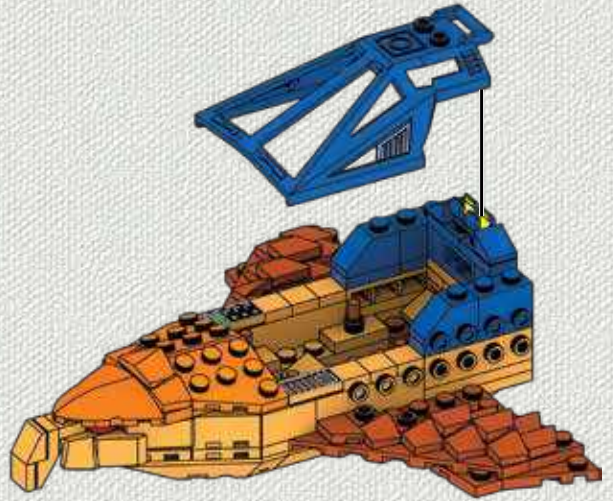
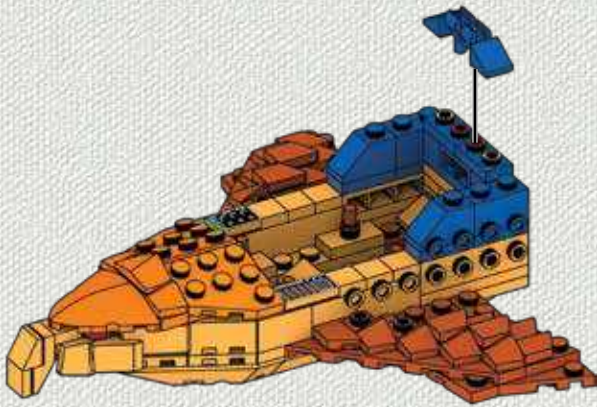

**154**

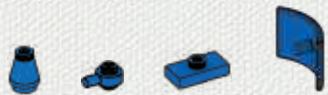

1X    1X    1X    1X

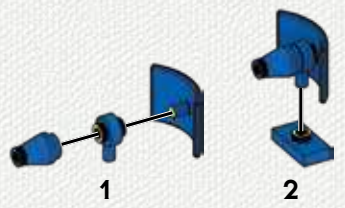

1    2



# 155

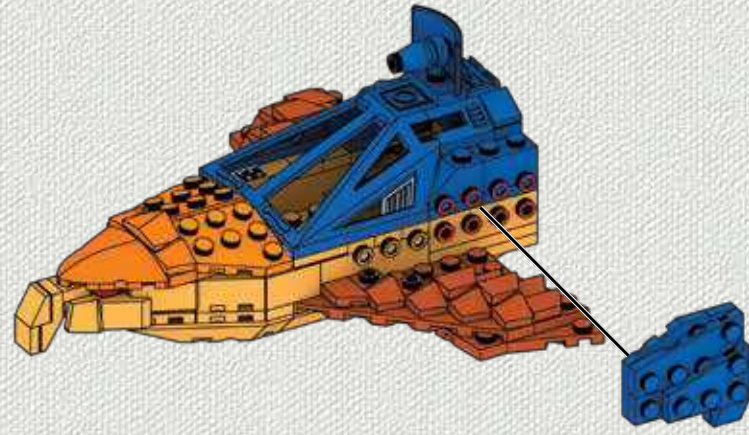
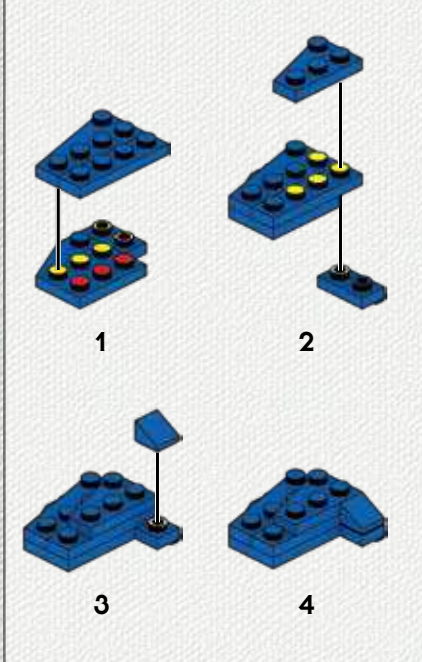
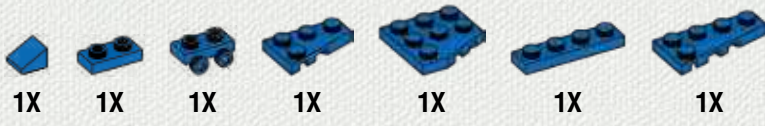

# 156

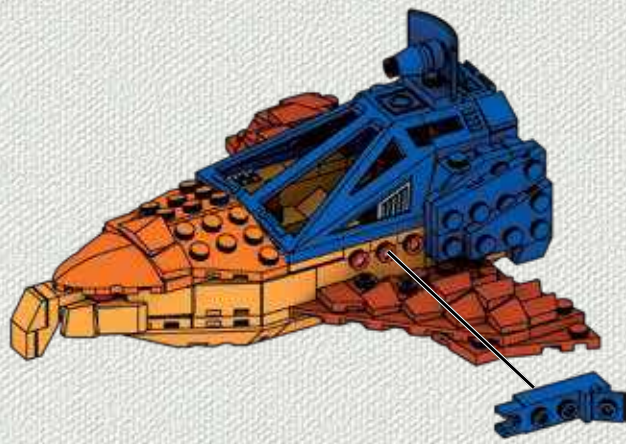
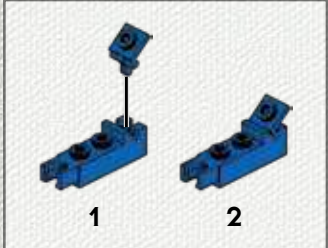
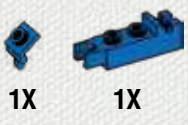

**157**

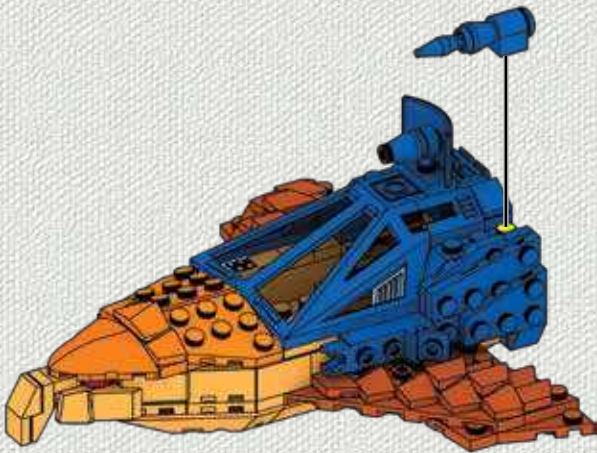
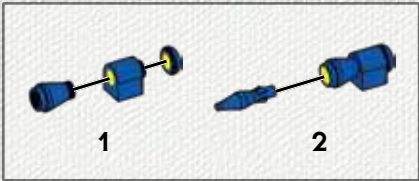

# 158

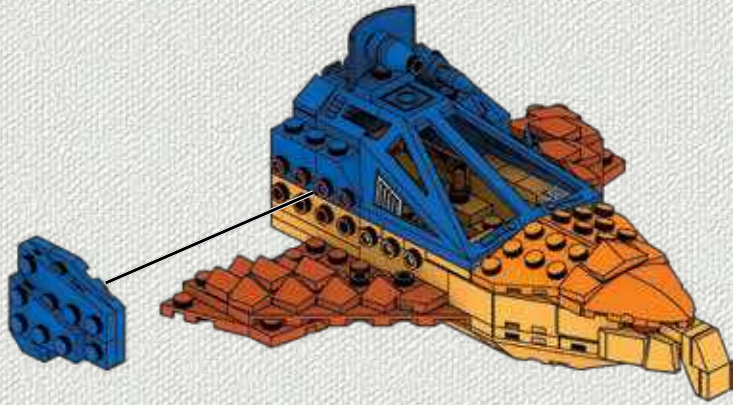
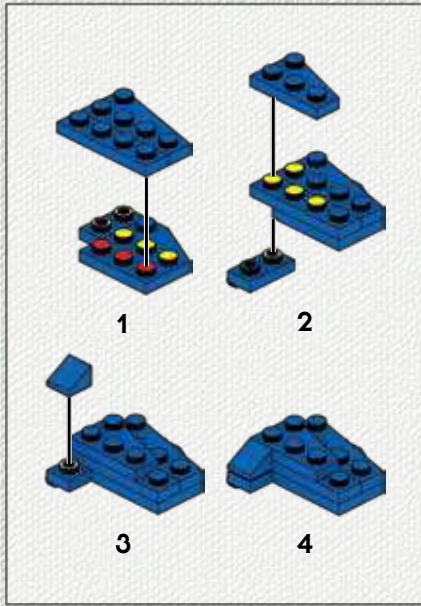

# 159

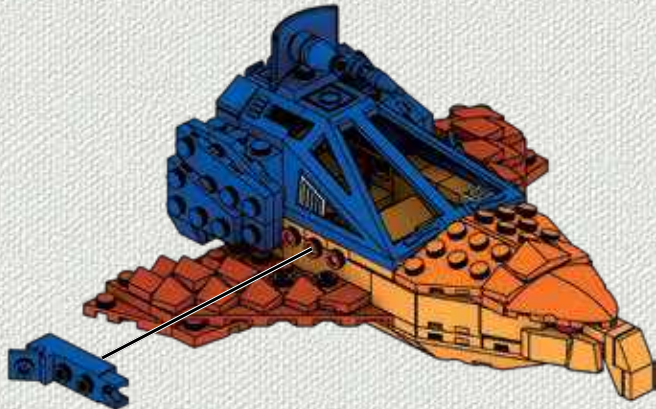
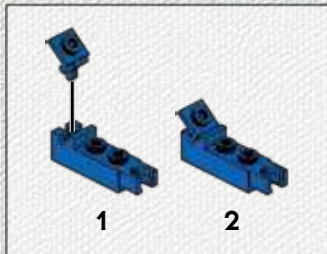
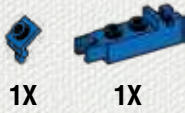

160

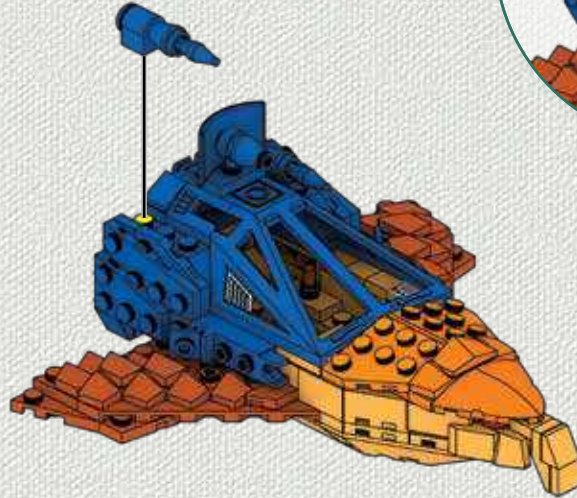
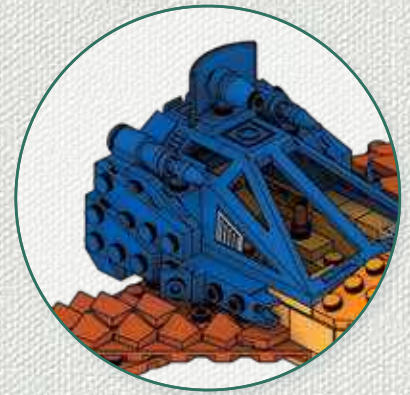

161

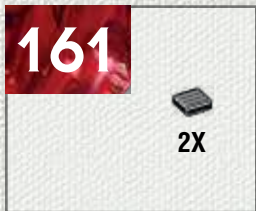

162

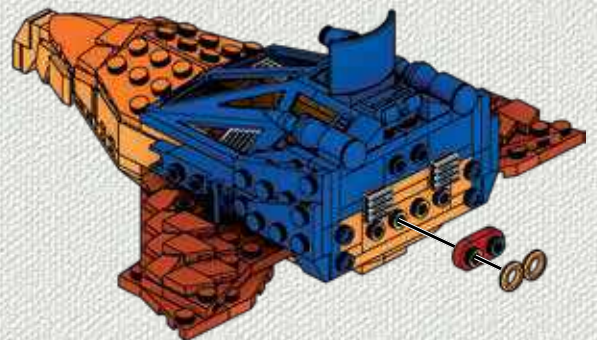
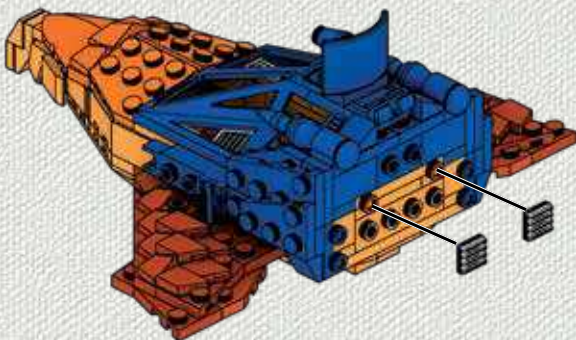
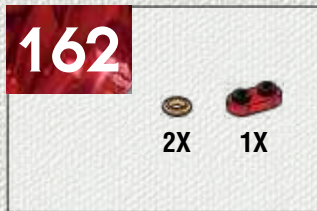

163

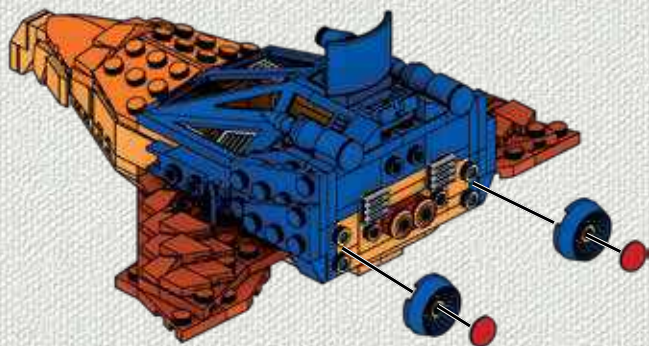

1

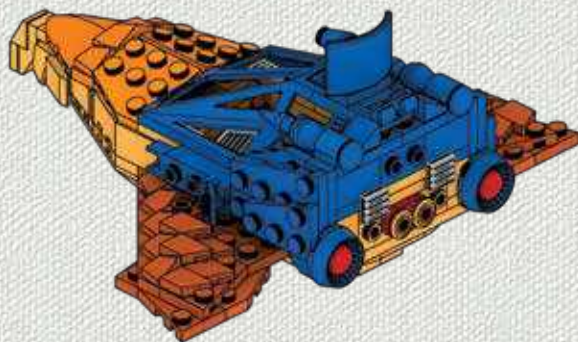

2

164

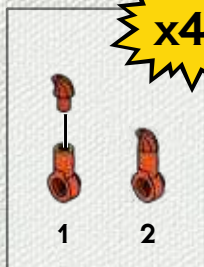

x4



1



2



3



4



165

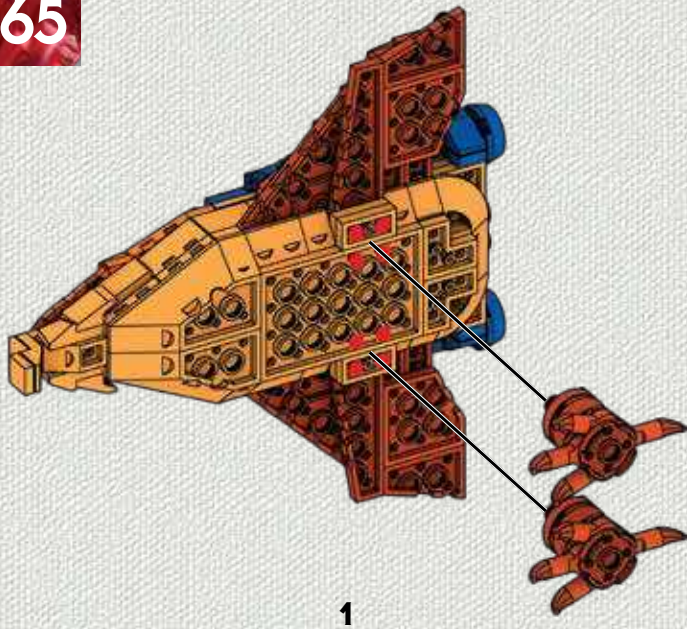

1

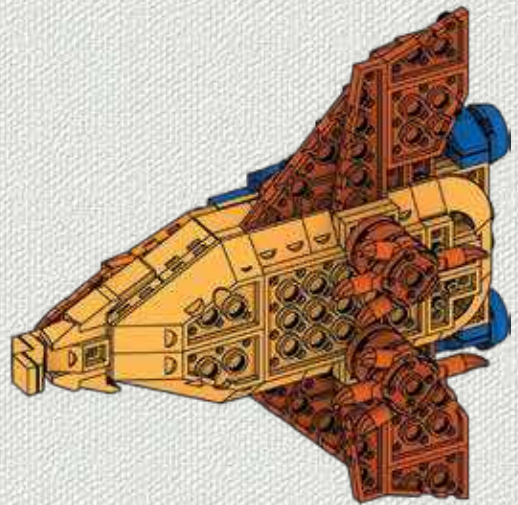

2

166



2X

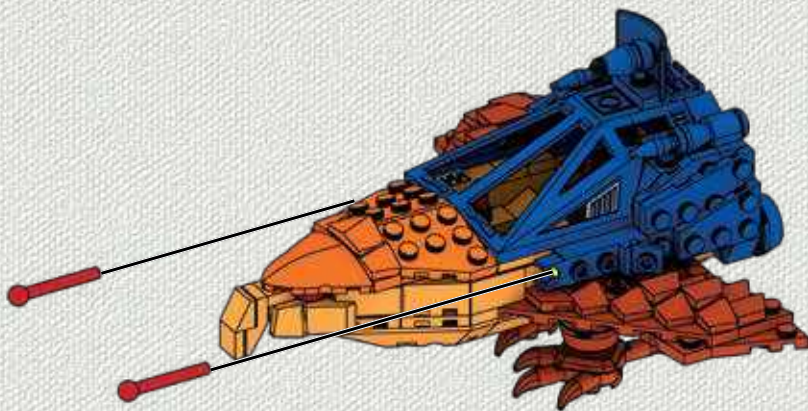

1

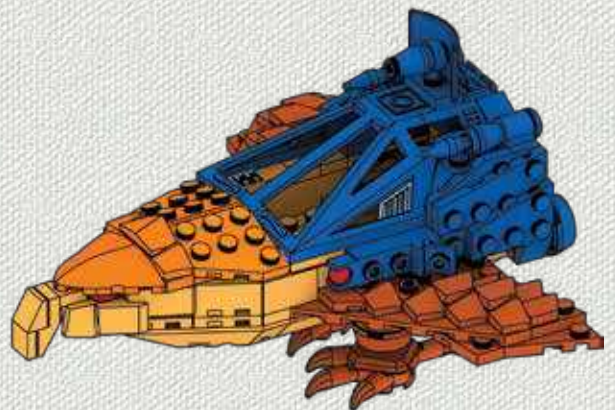

2



Warning: Do not aim at eyes or face. Only use projectiles supplied with this toy. Do not fire at point blank range. / Attention : Ne pas viser les yeux ou le visage. Ne pas utiliser d'autres projectiles que ceux fournis avec ce jouet. Ne pas tirer à bout portant. / Advertencia: No apuntar hacia los ojos o la cara. Utilizar exclusivamente los proyectiles suministrados con este juguete. No disparar a quemarropa. / ATENÇÃO!: Não apontar em direção aos olhos ou ao rosto. Usar apenas os projéteis fornecidos com este brinquedo. Não disparar à queima-roupa. / Avvertenza: Non mirare agli occhi o al viso. Usare solo i proiettili forniti con il giocattolo. Non sparare a distanza ravvicinata. / Achtung: Nicht auf Augen oder Gesicht zielen. Nur die zu diesem Spielzeug gehörenden Projektile verwenden. Nicht auf Menschen oder Tiere oder aus nächster Nähe zielen. / Ostrzeżenie: Nie celuj w oczy i twarz. Nie strzelaj pociskami innymi niż dostarczone z zabawką. Nie strzelaj z bliska. / Waarschuwing: niet op ogen of gezicht richten. Gebruik uitsluitend de bijgeleverde projectielen. Niet van te dichtbij afschieten. / Предупреждение: Не направляйте в глаза или лицо. Используйте только снаряды, входящие в комплект. Не стреляйте со слишком близкого расстояния. / Advarsel: Sigt ikke mod øjne eller ansigt. Brug kun de projektiler, som følger med legetøjet. Skyd ikke direkte på personer eller ting. / Varning: Sikta inte mot ögon eller ansikte. Använd endast projektiler som medföljer leksaken. Fyra lte av på mycket nära håll. / Advarsel: Du må ikke sikte mot øyne eller ansikt. Bruk bare prosjektilene som følger med leken. Ikke skyt på noe på kloss hold. / Varoitus: Älä tähtää silmiin äläkä kasvoihin. Käytä ainoastaan tämän tuotteen mukana tulleita ammuksia. Älä ammu lähietäisyydeltä. / Προσοχή: Μην στοχεύετε στα μάτια ή στο πρόσωπο. Χρησιμοποιείτε μόνο τα βλήματα που περιλαμβάνονται. Μην στοχεύετε όταν δεν έχετε ορατότητα. / Uyarı: Göze veya yüze nişan almayın. Fırlatmak için yalnızca bu oyuncakla birlikte verilen objeleri kullanın. İnsanlara ve hayvanlara nişan almayın. / Upozornění: Nemířte na oči nebo na obličej. Používejte pouze projektily dodávané s touto hračkou. Nestřílejte z bezprostřední blízkosti. / Upozornenie: Nemierte do očí ani do tváre. Používajte iba strely dodané spolu s touto hračkou. Nestriľajte z bezprostrednej blízkosti. / Figyelmeztetés: Tilos szemre és arcra célozni. Kizárólag a játékhoz mellékelt lövedékeket használja. A játékkal tilos közvetlen közelről lőni. / 警告: 目や顔を狙わないでください。このおもちゃに同梱されている発射物のみ使用するようにしてください。到達可能な距離内で火を燃やさないでください。

تحذير: يجب عدم التصويب باتجاه العينين أو الوجه. يجب استخدام المقذوفات المزودة مع هذه اللعبة فقط. يجب عدم الإطلاق من مدى قريب.  
**警告: 请勿对着眼睛或脸部发射。仅使用本玩具自带的抛射物。请勿近距离射击。**

CONNECT TOGETHER!  
 CONNECTEZ-LES!  
 ¡ÚNELOS!  
 CONECTE JUNTO  
 MITEINANDER  
 VERBINDEN  
 УСТАНОВКА  
 КОЛЬЦА ПРЕДТЕЧИ



GPH24



GGJ67

Additional purchase required. / Achat additionnel requis. / Zusätzlicher Kauf erforderlich. / Richiede acquisto addizionale. / Aanvullende aankoop vereist. / Requiere compra adicional. / Requer compra adicional. / Ytterligere kjøp kreves. / Edellyttä lisäosien ostamista. / Supplerende køb nødvendigt. / Ekstra kjøp kreves. / Wymagany dodatkowy zakup. / Vyžaduje dodatečný nákup. / Vyžaduje sa dokúpenie. / További vásárlás szükséges. / Необходима дополнительная покупка. / Απαιτείται επιπλέον αγορά. / Ek ürün satın alınması gerekir. / تتطلب شراء القطع الإضافية.

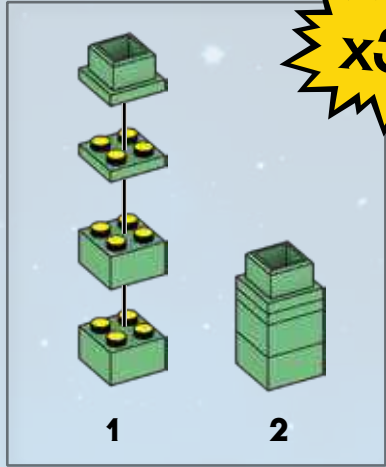

**2**



3X

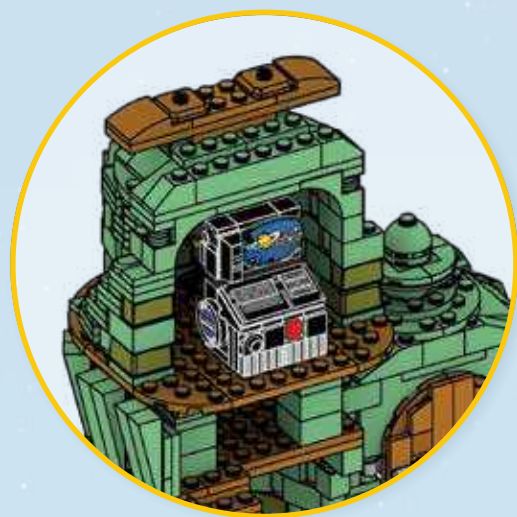
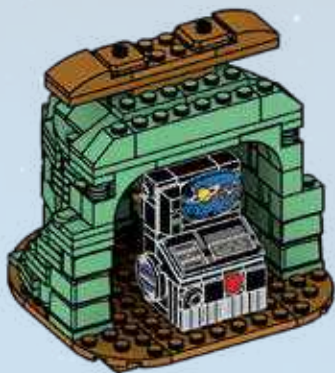
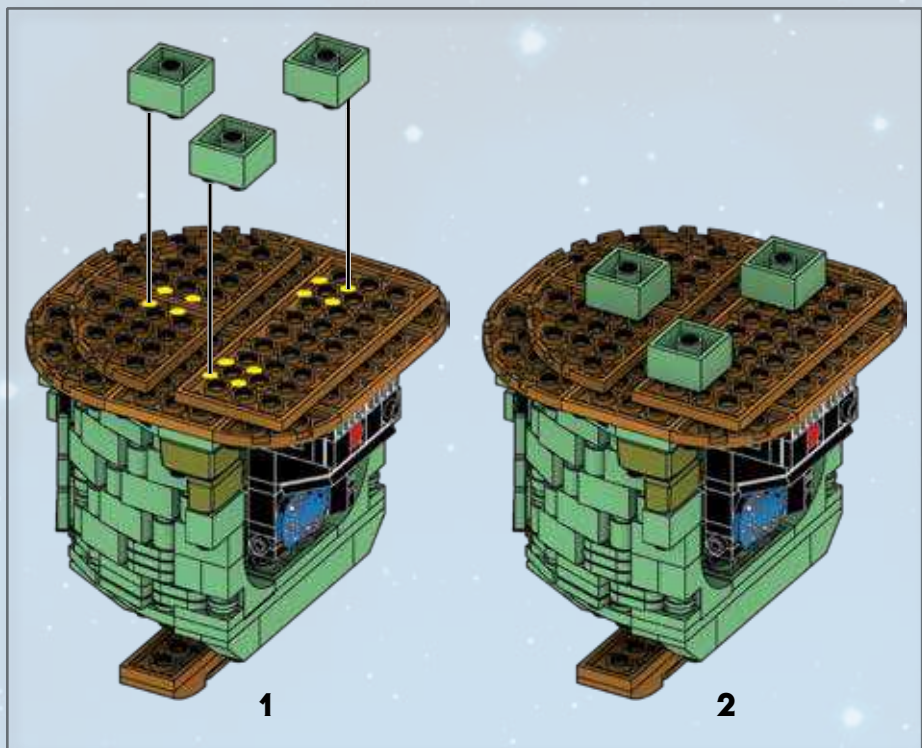

8x AM79425PH  
2x AM77341FM  
2x AM75332B  
3x AM75332AXW  
2x AM75332AXT  
10x MA1113AXT  
2x AM76204AXT  
2x AM78410MY  
1x AM79376F  
4x MA17127B  
1x MA17127FM  
2x MA17127AXT  
6x AM74299PH  
3x AM74299AXT  
6x AM74300PH  
3x AM74300AXT  
2x MA07223F  
1x MA07223FM  
2x AM79666F  
2x MA03328MY  
3x MA77574AXT  
2x AM79590FM  
2x AM79665AXT  
2x AM79665F  
7x AM79665FM

2x AM78273FM  
1x AM80010B  
8x AM80135PH  
1x MA76058MY  
1x MA74415MY  
2x AM78600B  
6x MA17003PH  
1x MA19392B  
6x MA17062MY  
3x MA17062BYE  
1x MA19617F  
2x M73904AWB  
2x AM75483B  
2x AM72001MY  
21x MA0910AXT  
1x AM02172AXT  
3x AM08412B  
2x MA07629AXT  
2x AM76767B  
2x MA09198F  
1x MA022501F  
3x MA022501AXT  
1x AS-GPH24-05  
1x AS-GPH24-06

4x AM80164AXT  
2x AM80174AXW  
26x AM80174AXT  
4x MA73758AXT  
4x MA07590FM  
1x MA07590MY  
1x MA07590B  
4x AM72494PH  
1x AM72494FM  
1x AM72494JU  
1x AM72495FM  
1x AM72495JU  
4x AM72495PH  
2x MA17018FM  
6x MA72002FM  
1x MA17131JU  
4x MA18549FM  
2x MA04430FM  
2x MA1322B  
4x MA1322AXT  
4x MA04429F

4x AM80573JU  
4x MA09393FM  
1x MA09393MY  
6x MA09393AXT  
2x MA16680F  
4x AM79246B  
2x MA76467B  
2x MA76467FM  
2x MA76467AXT  
4x AM79070B  
2x AM79070F  
1x MA72090B  
1x AS-GPH24-07  
2x MA02929TC  
17x MA09013AXT  
1x MA09013FM  
1x MA17502B  
1x MA17502F  
2x MA18665FM  
2x MA18666FM  
1x AM74672FM

1x AM74671FM  
1x MA18293FM  
4x MA15484FM  
2x MA17153FM  
2x MA17153B  
2x MA17010B  
2x MA17010PH  
1x AS-GPH24-04  
2x MA19380PH  
1x MA03484B  
2x MA74677PH  
2x AM73009PH  
2x AM73009MY  
1x MA03485B  
6x MA03773FM  
14x MA03773AXT  
4x MA0948AXT  
10x MA09023AXT

3x AM03157TC  
3x AM07578AXT  
3x MA18223FM  
2x MA10273AXT  
1x MA04497AXT  
1x AM17509AWB  
1x AM18742FM  
1x AM18741FM  
2x MA19899AXT  
2x MA19898AXT  
1x MA17073B  
2x MA17073PH  
1x MA17074B  
2x MA17074PH  
1x AM79101B  
2x AM78601AXW  
1x MA76521B  
4x MA72600MY  
2x MA09593B

3x MA09593FM  
1x MA09593JU  
2x MA09593PH  
2x MA09593F  
1x MA09838AXT  
2x AM78599B  
1x AS-GPH24-01  
1x AM75525JU  
1x AM75526JU  
2x MA1141F  
4x AM78916AXT  
4x MA1323AXT  
2x AM19012MY  
1x MA03873F  
1x AM72089JZ  
1x MA1087F  
2x MA1087FM  
1x MA17503F

3x MA17503FM  
1x MA74065B  
1x MA74064B  
3x MA09493MY  
2x MA09493F  
1x AS-GPH24-08  
2x MA09033AXT  
1x AM18282PH  
1x AM18282JU  
1x AM18282AXT  
1x AM18282B  
1x AM18283PH  
1x AM18283JU  
1x AM18283AXT  
1x AM18283B  
2x MA17056MY



3x  
MA76357AXT

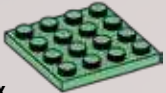

1x  
MA17054AXT



1x  
AM17008FM



1x  
AM17007FM



2x  
MA07475MY



3x  
MA09292FM



3x  
MA09292MY



1x  
MA72011PH



1x  
MA72010PH



1x  
MA1313AXT



1x  
MA1480FM



1x  
MA1480MY



2x  
AM18259B

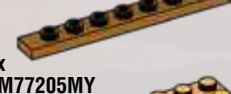

2x  
AM77205MY



3x  
MA08483FM



1x  
MA09923MY



1x  
MA09923AXT



1x  
MA09924MY



4x  
AM09622MY

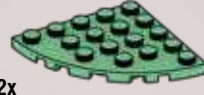

2x  
AM09622AXT



2x  
MA17055MY



1x  
MA17055FM



2x  
AM04219PH



1x  
MA73222AXT



1x  
FIG-GPH24-A



1x  
FIG-GPH24-B



1x  
FIG-GPH24-C



1x  
FIG-GPH24-D



1x  
AS-GPH24-03



1x  
AM80845VF



1x  
AM80855MCX



1x  
AS-GPH24-02



1x  
AM80197B



1x  
AM80200B



1x  
AM80198B

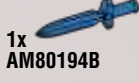

1x  
AM80194B



1x  
AM80199B



1x  
AM80195B



1x  
AM80201B



1x  
AM80196B



1x  
AM80201AMC



1x  
AM80193E



1x  
AM79763SX



1x  
AM16764E



1x  
AM80413E

Mattel Europa B.V., Gondel 1, 1186 MJ Amstelveen, Nederland. Mattel U.K. Limited, The Porter Building, 1 Brunel Way, Slough SL1 1FQ, UK. Mattel France, Parc de la Ceraise, 1/3/5 allée des Fleurs, 94260 Fresnes Cedex. N° Cristal 0969 36 99 99 (Numéro non surtaxé) ou www.lesjouetsmattel.fr Mattel Belgium, Trade Mart, Atomiumsquare, Bogota 202 - B 275, 1020 Brussels. Gratis nummer België: 0800 - 16 936 - Gratis nummer Luxemburg: 800 - 22 784 - Gratis nummer Nederland: 0800 - 262 88 35. Deutschland: Mattel GmbH, Solmsstraße 4, D-60486 Frankfurt am Main. Schweiz: Mattel AG, Kirchstrasse 24, CH-3097 Liebefeld. Österreich: Mattel Ges.m.b.H., Campus 21, Liebermannstraße A01 404, A-2345 Brunn/Geirgibe. Mattel Italy Srl, Via Bracco, 6-MAC 6, 20159 Milano, Italy. Servizio assistenza clienti: Customersrv.italia@mattel.com - Numero verde 800 11 37 11. Mattel España, S.A., Aribau 200, 08036 Barcelona. cservice.spain@mattel.com Tel: 902203010 http://www.service.mattel.com/es. Mattel East Asia Ltd., Room 503-09, North Tower, World Finance Centre, Harbour City, Tsimshatsui, HK, China. Tel: (852) 3185-6500. Diimport & Diedarkan Oleh: Mattel Continental Asia Sdn Bhd. Level 19, Tower 3, Avenue 7, No. 8 Jalan Kerinchi, Bangsar South, 59200 Kuala Lumpur, Malaysia. Mattel South Africa (PTY) LTD, Office 102 B, 30 Melrose Boulevard, Johannesburg 2196. Dystrybutor: Mattel Poland Sp. z o.o., Warsaw Trade Tower 34 p., ul. Chłodna 51, 00-867 Warszawa. Mattel Australia Pty. Ltd., 658 Church St, Richmond, Victoria, 3121. Consumer Advisory Service - 1300 135 312. Mattel AEBE, Εθνάρχου Μακαρίου 1, Κτήριο Κ-2, ΤΚ 17561, Πολυάθροισμα. Mattel Oyuncakçılık Tic. Ltd. Şti. İçerenköy Mah., Erkut Sok. A Blok No:12 Üner Plaza Kat:9-10 34752 Ataşehir İstanbul. Tel: 0216 570 75 00. Импортёр/Уполномоченная организация: ООО "МАТЕЛ" Российская Федерация, 105120 Москва, 2-й Сыромятинский переулок; +7 495 287 79 39. Forg.: Mattel Toys Hungary Kft 1139 Budapest Váci út 91. +36 1 270 0223. Mattel Czech Republic s.r.o., The Forum, Václavské nám. 19, 11000 Praha 1. Mattel, Inc. 636 Girard Avenue, East Aurora, NY 14052, U.S.A. Mattel Canada Inc., Mississauga, Ontario L5R 3W2. Consumer Services: You may call us free at /Composez sans frais le 1-800-524-8697. Importado y distribuido por Mattel de México, S.A. de C.V., Miguel de Cervantes Saavedra No. 193, Pisos 10 y 11, Col. Granada, Alcaldía Miguel Hidalgo, C.P. 11520, México, Ciudad de México. R.F.C. MME-920701-NB3. Tels: 59-05-51-00 Ext. 5206 ó 01-800-463-59-89. Mattel Chile, S.A., Avenida América Vespucio 501-B, Quilicura, Santiago, Chile; 1230-020-6213. Servicio al consumidor Venezuela: Tel: 0-800-100-9123. Mattel Argentina, S.A., Av. Libertador 1000, Piso 11 - Oficinas 109 y 111, Vicente López - Prov. Buenos Aires, Tel.: 0800-666-3373. Mattel Colombia, S.A., Calle 123#7-07 P5, Bogotá, Tel.: 01800-710-2069. Mattel Perú, S.A., Av. Juan de Arona # 151, Centro Empresarial Juan de Arona, Torre C, Piso 7, Oficina 704, San Isidro, Lima 27, Perú. RUC: 20425853865. Reg. Importador: 02350-12-JUE-DIGESA. Tel: 0800-54744. E-mail Latinoamérica: servicio\_clientes@mattel.com. Mattel do Brasil Ltda.- CNPJ: 54.558.002/0001-20 - Rua Verbo Divino, 1488 - 2º Andar - 04719-904 - Chácara Santo Antônio - São Paulo - SP - Brasil. Serviço de Atendimento ao Consumidor: fone 0800-550780. E-mail: sac.matteldobrazil@mattel.com

MEGA™  
CONSTRUX

MASTERS  
OF THE UNIVERSE™

**MORE TO COLLECT! / ENCORE PLUS À COLLECTIONNER!  
¡MÁS PARA COLECCIONAR! / MAIS PARA COLECIONAR!  
MEHR ZUM SAMMELN! / СОБЕРИ БОЛЬШЕ!**



GPH23

Set(s) sold separately and subject to availability. / Ensemble(s) vendu(s) séparément. Certains produits peuvent ne pas être commercialisés. / Se vende(n) por separado y está(n) sujeto(s) a disponibilidad. / Conjunto(s) vendido(s) em separado e sujeito(s) à disponibilidade. / Set in vendita separatamente, secondo disponibilità. / Das/Die Set(s) sind separat erhältlich. / Zestaw(y) sprzedawany(e) oddzielnie w zależności od dostępności. / Set(s) apart verkrijgbaar en afhankelijk van beschikbaarheid. / Набор(-ы) продаются отдельно, при наличии. / Sæt sælges separat og så længe lager haves. / Seten säljs separat så länge lagret räcker. / Settet/settene selges separat så langt lageret rekker. / Pakkaus/pakkaukset myydään erikseen, saatavuus voi vaihdella. / Το(α) σετ πωλούνται ξεχωριστά και ανάλογα με τη διαθεσιμότητα. / Setler ayrı olarak satılır ve stoklarla sınırlıdır. / Set (sety) se prodává (prodávají) samostatně dle aktuální nabídky. / Súprava/-y sa predáva(jú) samostatne a podľa dostupnosti. / A készlet(ek) külön kapható(k), az elérhetőség változhat. / セット商品は別売りになります。在庫状況は別途ご確認ください。 / تُباع المجموعة أو المجموعات على حدة وتخضع لتوافرها. /

每套单独发售，按供货情况决定。

MEGA Brands Inc. Montreal QC H4T 1K4 Canada

ASSEMBLED IN CANADA WITH DOMESTIC AND IMPORTED COMPONENTS. ASSEMBLÉ AU CANADA AVEC DES ÉLÉMENTS DOMESTIQUES ET IMPORTÉS. MONTADO NO CANADÁ COM COMPONENTES NACIONAIS E IMPORTADOS. MONTADO EN CANADÁ CON PIEZAS FABRICADAS EN CANADÁ Y PIEZAS IMPORTADAS. СБОРКА ВЫПОЛНЕНА В КАНАДЕ С ОТЕЧЕСТВЕННЫМИ И ИМПОРТНЫМИ КОМПОНЕНТАМИ. ИЗГОТОВЛЕНО В КИТАЕ. YERLI VE İTHAL PARÇALARLA KANADA'DA MONTE EDİLMİŞTİR. صنع في كندا من مواد محلية ومستوردة.



**BUILD & SHARE  
CONSTRUIRE ET PARTAGER**  
CONSTRUYE Y COMPARTE | MONTAR E  
COMPARTILHAR | BAUEN UND MIT  
ANDEREN TEILEN | СОЗДАВАЙ И ДЕЛИСЬ  
[megaconstrux.com](http://megaconstrux.com)

© D714,887, D781,964, D797,203,  
D809,611, D835,727, D841,101

1186 MJ, 1, NL



©2020, MEGA Brands Inc. & MEGA Brands Inc. CONSTRUX™ is owned by Mattel and used under license. CONSTRUX™ appartient à Mattel et est utilisée sous licence. Printed in Canada / Imprimé au Canada D-GPH24-02

HE-MAN™, MASTERS OF THE UNIVERSE™ and associated trademarks and trade dress are owned by, and used under license from Mattel, Inc. ©2020 Mattel. All Rights Reserved.

MIX  
Paper from responsible sources  
Papier issu de sources responsables  
FSC® C011825